

أهلاً ميدتاون...
أهلاً بالحياة!

HELLO MIDTOWN...
HELLO LIFE!

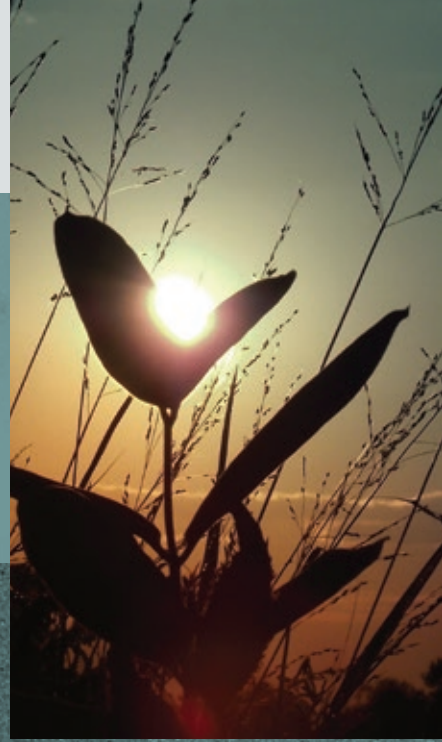

NOOR

M
MIDTOWN
BY DEYAAR

أهلاً بالحياة في ميدتاون.

WELCOME TO THE MIDTOWN WAY OF LIFE.



Midtown is a signature township developed by Deyaar. It has won the prestigious Best Real Estate Project – Affordable Housing Award at the Gulf Real Estate Awards 2018.

From the lifestyle and fitness amenities to the convenient services and easy connectivity, our handpicked partners ensure that Midtown lives up to your every expectation, providing quality living, optimal value and solid returns on investment.

ميدتاون هو أبرز مشاريع شركة ديار وقد حصد المشروع جائزة «أفضل مشروع عقاري» عن فئة «المشاريع السكنية الميسرة» خلال حفل توزيع جوائز الخليج العقارية 2018.

ينفرد هذا المشروع بأسلوب الحياة الفريد والمرافق الرياضية والخدمات وسهولة الوصول. لقد حرصنا على اختيار شركائنا بدقة لتلبية تطلعات عملائنا وتوفير مستويات مميزة من العيش بقيمة مميزة وعائدات مجزية.



NOOR | **M**
MIDTOWN
BY DEYAR

في قلب المدينة
AT THE HEART
OF LIVING.



3.7 km | 6 mins
سيتي سنتر معيصم
CITY CENTRE
ME'AISEM



6 km | 10 mins
نخيل مول
NAKHEEL MALL



17.3 km | 16 mins
مول الإمارات
MALL OF THE
EMIRATES



13.0 km | 14 mins
مدرسة دبي البريطانية
DUBAI BRITISH SCHOOL

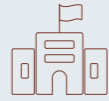

10.2 km | 10 mins
مدرسة جيمس ميتروبول
GEMS METROPOLE SCHOOL

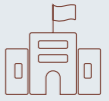

10 km | 8 mins
مدرسة الشويفات الدولية
THE CHOUEIFAT
INTERNATIONAL SCHOOL

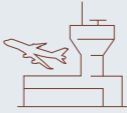

43.1 km | 28 mins
مطار دبي الدولي
DUBAI INTERNATIONAL
AIRPORT

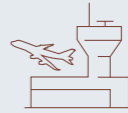

39.8 km | 24 mins
مطار آل مكتوم الدولي
AL MAKTOUM
INTERNATIONAL AIRPORT



5 km | 6 mins
مترو
METRO



22.0 km | 20 mins
نخلة جميرا
PALM JUMEIRAH



17.0 km | 15 mins
الممشى مساكن شاطئ جميرا
THE WALK JBR



26.9 km | 19 mins
برج خليفة/ دبي مول
BURJ KHALIFA/
DUBAI MALL



14.1 km | 14 mins
تلال الإمارات
EMIRATES HILLS



5.7 km | 8 mins
مدينة دبي الرياضية
DUBAI
SPORTS CITY



14.2 km | 12 mins
المرايح العربية
ARABIAN RANCHES

Introducing Noor, the third district of Midtown. An all-inclusive community within vast open spaces and landscapes, Midtown offers an array of conveniently located retail and F&B options, including outdoor facilities and sports amenities. Choose from studio, 1, 2 or 3 bedroom apartment layouts. It will be your personal space with vibrant, modern interiors, premium finishes and all the amenities you need.

اكتشفوا الحياة في مجمّع عصري
DISCOVER URBAN
COMMUNITY
LIVING.



نقدم لكم نور، المنطقة الثالثة من ميدتاون، المجمع السكني المتكامل الذي يضم مساحات فسيحة ومناطق خضراء. يضم هذا المجمع العصري مجموعة متنوعة من متاجر التجزئة والمطاعم، بالإضافة إلى العديد من وسائل الترفيه في الهواء الطلق والمرافق الرياضية. يتميز المشروع بتوفيره شققاً مكونة من استديو وغرفة وغرفتين وثلاث غرف نوم. تمتاز هذه الشقق بتصميمها الداخلي والتي صممت بأسلوب عصري وبلمسات راقية، بالإضافة إلى توفيرها لكافة الخدمات التي تحتاجها.



What makes Noor special is the vibrant community space it creates that is both personal and secure. The green concourse links all the residential buildings connecting residents to a refreshing green retreat of open lawns, play areas as well as outdoor seating. Designed with amenities for a fit and healthy lifestyle, Noor also includes a retail boulevard featuring convenience stores, laundry stores, pharmacies, supermarkets, multi-cuisine restaurants and cafés.

إن أهم ما يميز منطقة نور ديستركت هو توفيرها لمجتمع ينبض بالحياة يتيح للسكان الاستمتاع بالخصوصية والأمان في الوقت نفسه. ترتبط جميع المباني السكنية ببعضها من خلال منطقة خضراء تعتبر بمثابة منصة مشتركة للسكان وتضم مناطق لعب للأطفال، بالإضافة إلى المقاعد والجلسات. تم تجهيز نور بمرافق خدمية لتعزيز اللياقة ونمط الحياة الصحي. كما تضم نور منطقة المتاجر والتي تشمل مصبغة للملابس، وصيدلية، وسوبر ماركت ومطاعم ومقاهي.



جودة حياة عصرية مصممة لراحتك

A QUALITY
OF LIFE BUILT
AROUND YOU.

AMENITIES & FACILITIES: المرافق والخدمات



مطاعم ومقاهي
Restaurants and cafes



مصلى
Prayer facilities



ملاعب للأطفال
Children's playgrounds



مسار للركض
Jogging track



نادي صحي
Health club



مساحات خضراء
Landscaped open piazza



متاجر تجرئة
Retail promenade



ملاعب للتنس
Tennis courts



برك للسباحة وبركة سباحة للأطفال
Swimming pools and kids pool



مناطق عائلية مغطاة
Shaded family areas



مركز لرعاية الأطفال
Child day-care centre

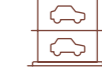

مواقف سيارات
Parking bays



ملاعب لكرة السلة
Basketball courts

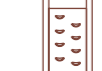

جدران للتسلق
Traverse climbing walls



أجهزة رياضية في الخارج
Outdoor gym equipment



شقة مكونة من غرفة نوم واحدة
ONE BEDROOM APARTMENT





شقة مكونة من غرفتي نوم
TWO BEDROOM APARTMENT



لزيارة شقة العرض، أو لمزيد من المعلومات عن نور، يرجى الإتصال بنا:

مركز مبيعات ديار، برج بيرلينغتون، الخليج التجاري، دبي
الإمارات العربية المتحدة: (339227) DEYAAR - 800
من أي مكان في العالم: +971 4 3840950

TO ARRANGE A PRIVATE VIEWING OR FOR MORE
INFORMATION ON NOOR, PLEASE CONTACT US AT:

DEYAAR SALES CENTRE, BURLINGTON TOWER, BUSINESS BAY, DUBAI.
800 - DEYAAR (339227) | INTERNATIONAL: +971 4 3840950
WWW.MIDTOWN.AE

المخطط الرئيسية MASTER PLAN



- 1 ملعب التنس / الريشة الطائرة
BADMINTON / TENNIS COURT
- 2 بركة سباحة للعوائل
FAMILY SWIMMING POOL
- 3 بركة سباحة للأطفال
CHILDREN'S POOL
- 4 مسار للجري
JOGGING TRACK
- 5 أجهزة رياضية في الخارج
OUTDOOR GYM EQUIPMENT

- 6 جدران للتسلق
LATERAL CLIMBING WALL
- 7 ملعب لكرة السلة
BASKETBALL COURT
- 8 مرافق لتغيير الملابس
CHANGING FACILITIES
- 9 مناطق لعب للأطفال
CHILDREN'S PLAY AREA
- 10 مساحات مغطاة بالحصى
GRAVEL COURTYARDS

- 11 مساحات مفتوحة/مساحات مخصصة للمناسبات
OPEN LAWNS/EVENTS SPACE
- 12 محال تجارية - مطاعم ومقاهي
RETAIL - F&B OUTLETS
- 13 صالة رياضية، قاعة متعددة الاستخدامات ومرافق لتغيير الملابس
GYM, MULTIPURPOSE HALL & CHANGING FACILITIES
- 14 مدخل لمواقف السكان
RESIDENTS PARKING ENTRANCE

- 15 ممشى مركزي
CENTRAL WALK
- 16 مشاريع مستقبلية
FUTURE DEVELOPMENT
- 17 مواقف للزوار
VISITORS PARKING



نور 3
استديو - نموذج B & C
NOOR 3
STUDIO APARTMENT - TYPE B & C

ST/B

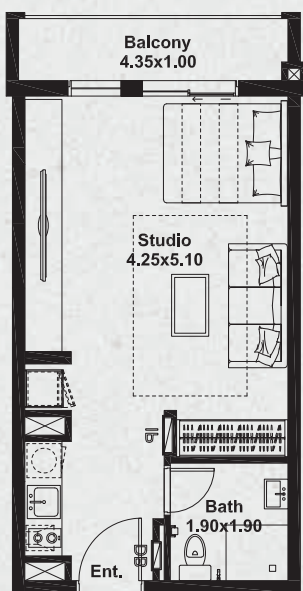

ST/C

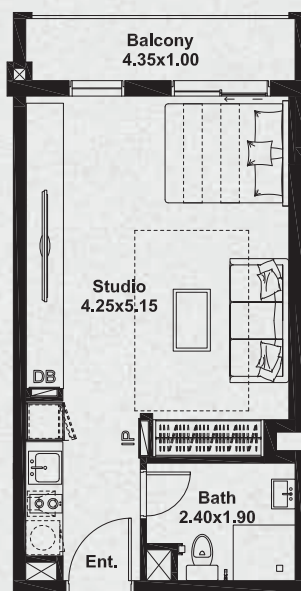

TYPE	LEVEL	UNIT (SQ.FT)	BALCONY (SQ.FT)	TOTAL (SQ.FT)
ST/B	9-16	380	56	436
ST/C	9-16	384	56	440

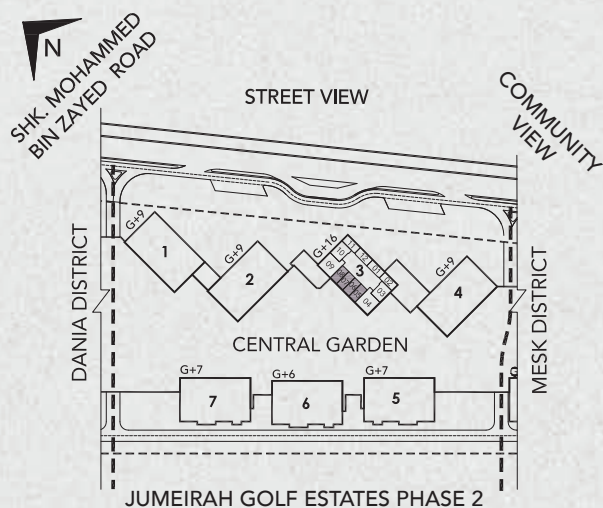

NOOR 3

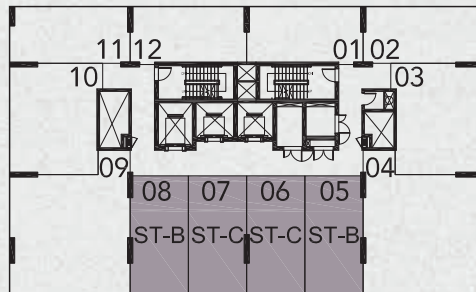

LEVEL 10-16

NOOR 3

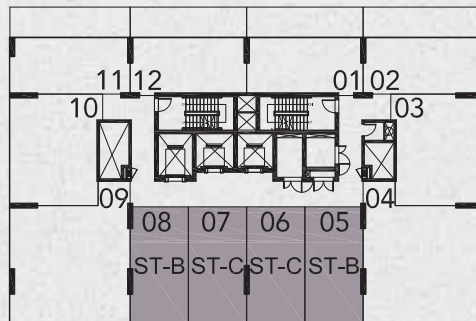

LEVEL 9

نور 3
استديو - نموذج D & E
NOOR 3
STUDIO APARTMENT - TYPE D & E

ST/D

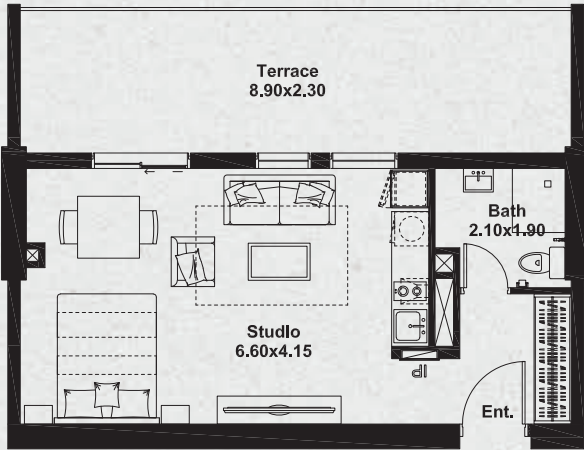

ST/E

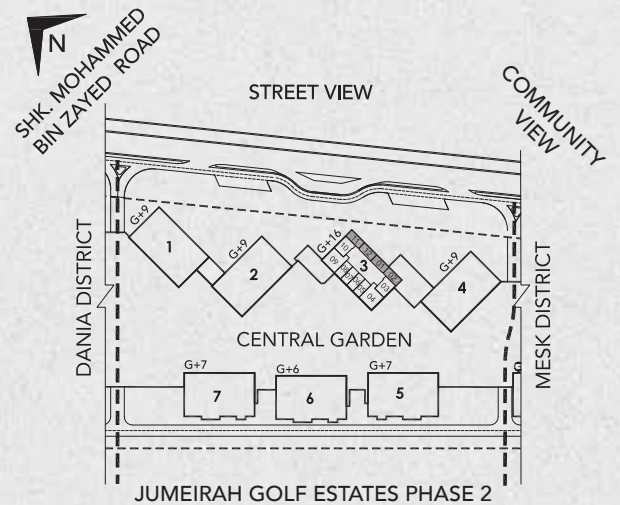
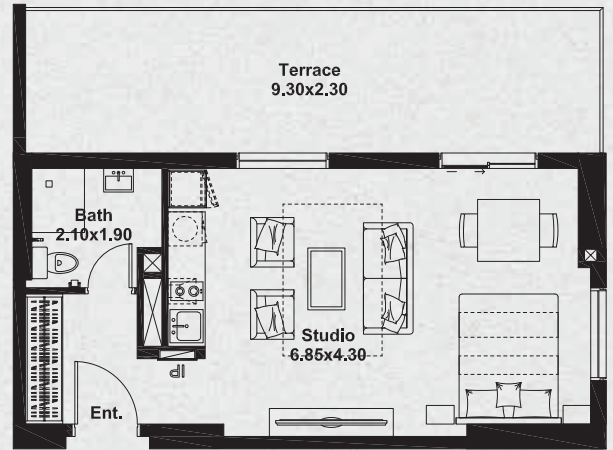

TYPE	LEVEL	UNIT (SQ.FT)	BALCONY (SQ.FT)	TOTAL (SQ.FT)
ST/D	9	427	240	667
ST/E	9	443	248	691

NOOR 3

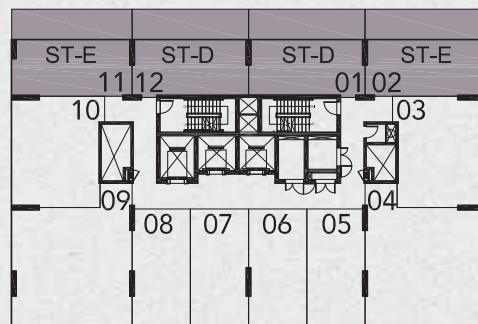

LEVEL 9

نور 3
استديو - نموذج F & G
NOOR 3
STUDIO APARTMENT - TYPE F & G

ST/F

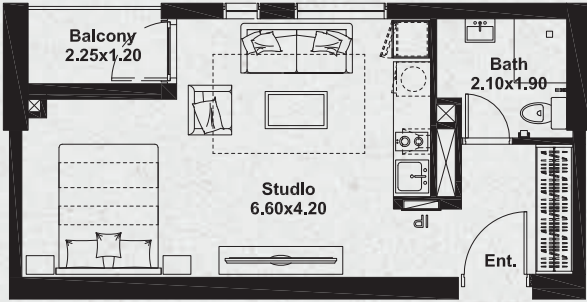

ST/G

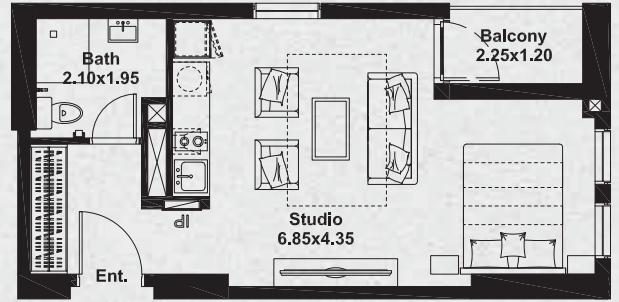

TYPE	LEVEL	UNIT (SQ.FT)	BALCONY (SQ.FT)	TOTAL (SQ.FT)
ST/F	10-16	394	37	431
ST/G	10-16	406	37	443

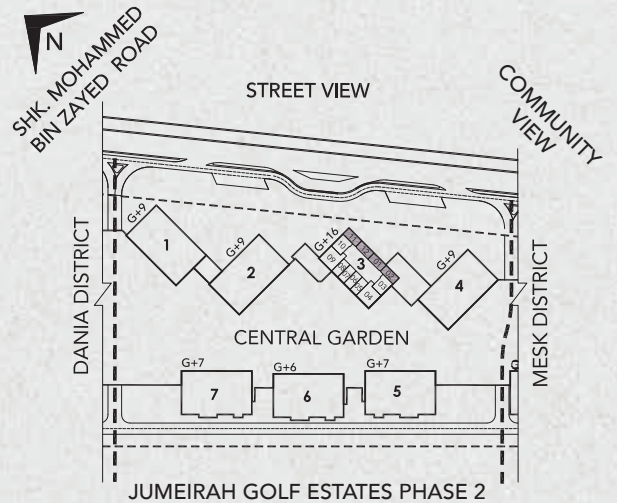

NOOR 3

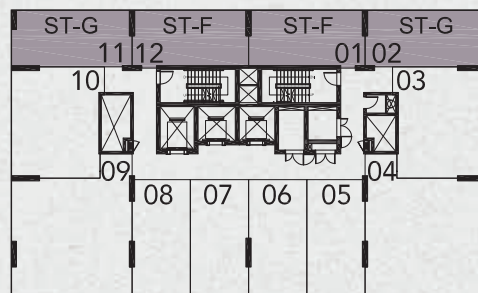

LEVEL 10-16

نور 1, 2, 3 & 4
استديو - نموذج H
NOOR 1, 2, 3 & 4
STUDIO APARTMENT - TYPE H

ST/H

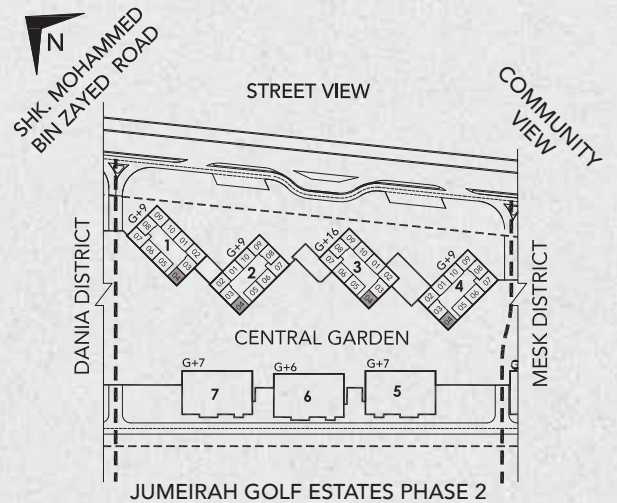
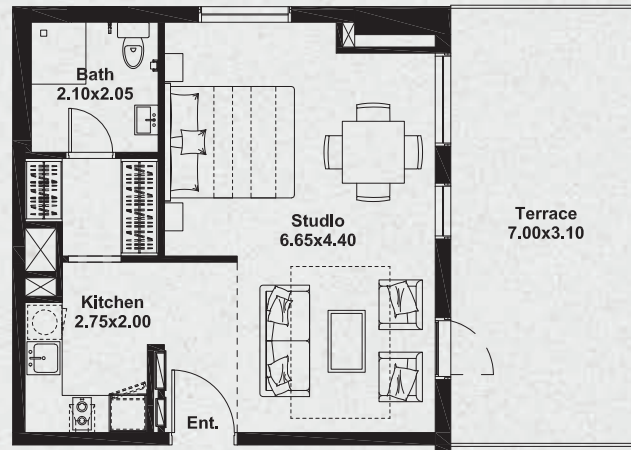

TYPE	LEVEL	UNIT (SQ.FT)	BALCONY (SQ.FT)	TOTAL (SQ.FT)
ST/H	1	486	246	732

NOOR 3

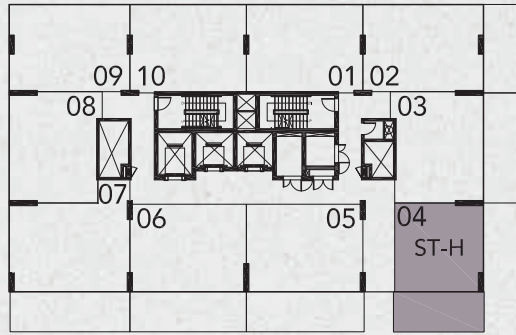

LEVEL 1

NOOR 2 & 4

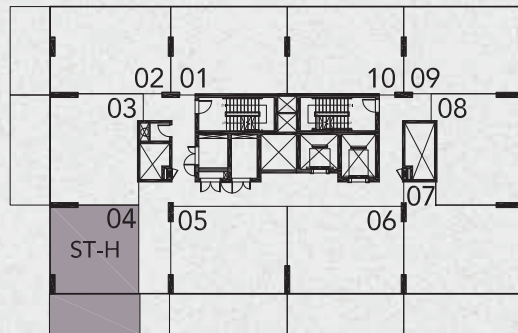

LEVEL 1

NOOR 1

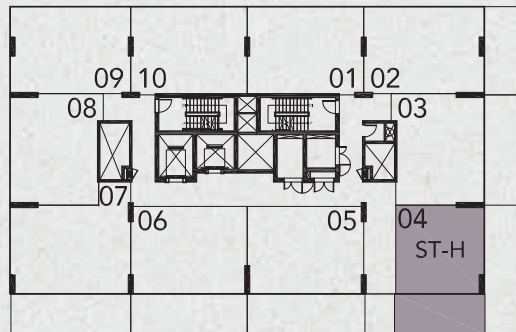

LEVEL 1

نور 1, 2, 3 & 4
شقة مكونة من غرفة نوم واحدة - نموذج A
NOOR 1, 2, 3 & 4
ONE BEDROOM APARTMENT - TYPE A

1BR/A

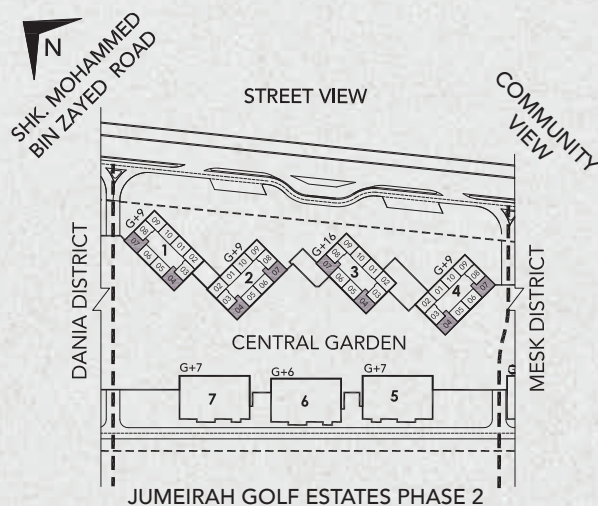
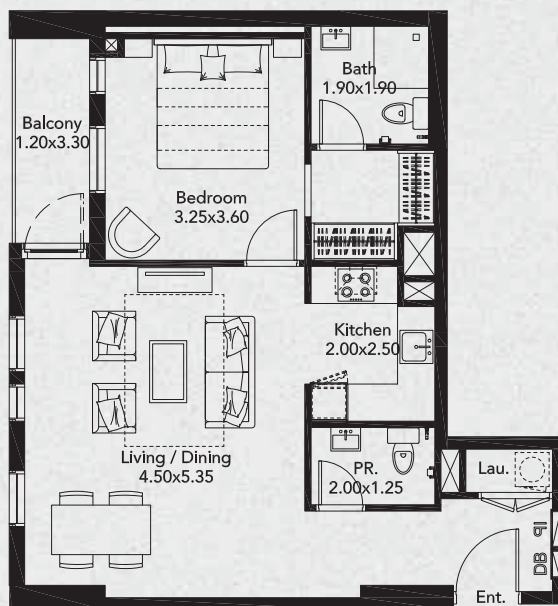

TYPE	LEVEL	UNIT (SQ.FT)	BALCONY (SQ.FT)	TOTAL (SQ.FT)
1BR/A	2-9	682	53	735

NOOR 3

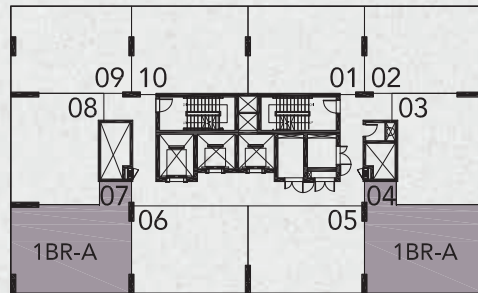

LEVEL 2-8

NOOR 2 & 4

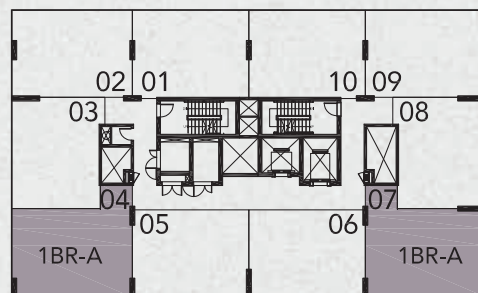

LEVEL 2-9

NOOR 1

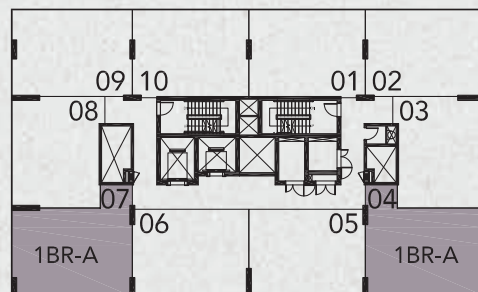

LEVEL 2-9

نور 1, 2, 3 & 4
شقة مكونة من غرفة نوم واحدة - نموذج B
NOOR 1, 2, 3 & 4
ONE BEDROOM APARTMENT - TYPE B

1BR/B

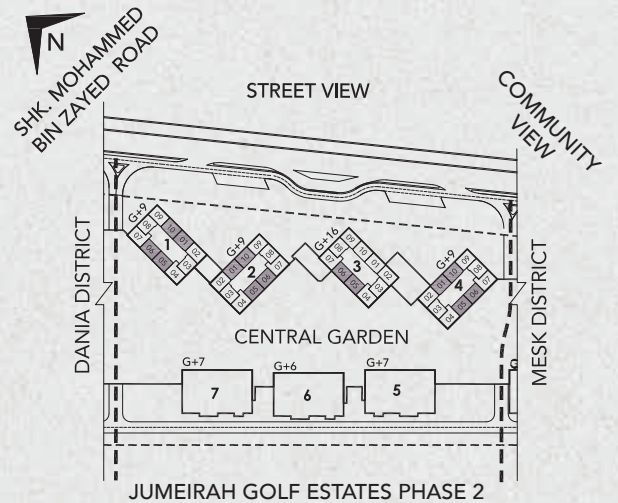
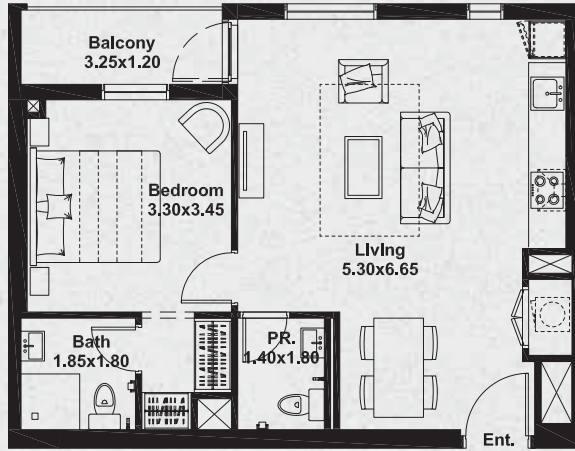

TYPE	LEVEL	UNIT (SQ.FT)	BALCONY (SQ.FT)	TOTAL (SQ.FT)
1BR/B	1-9	607	51	658
	2-9	586	51	637

NOOR 2 & 4

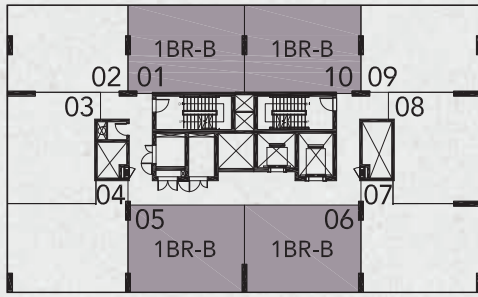

LEVEL 2-9

NOOR 2 & 4

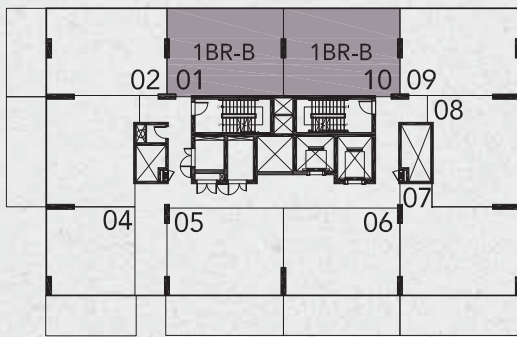

LEVEL 1

NOOR 1

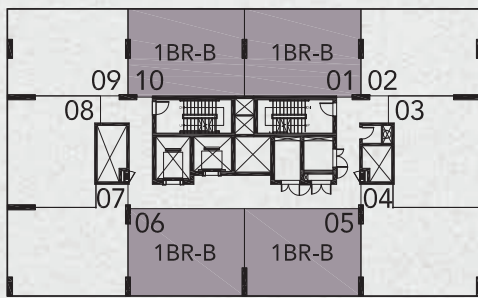

LEVEL 2-9

NOOR 1

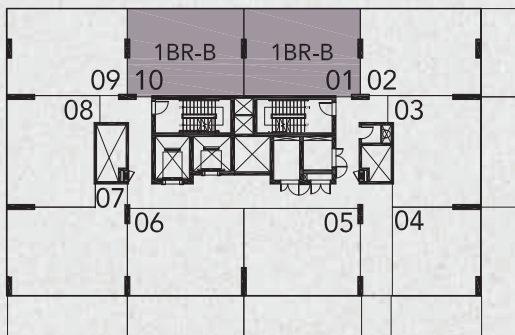

LEVEL 1

NOOR 3

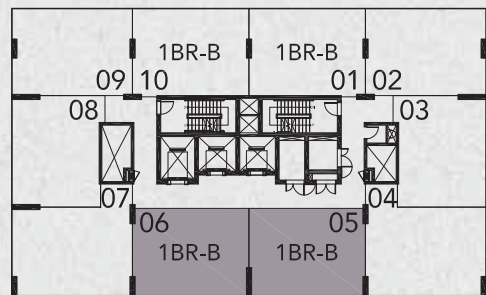

LEVEL 2-8

نور 3

شقة مكونة من غرفة نوم واحدة - نموذج *B

NOOR 3

ONE BEDROOM APARTMENT - TYPE B*

1BR/B*

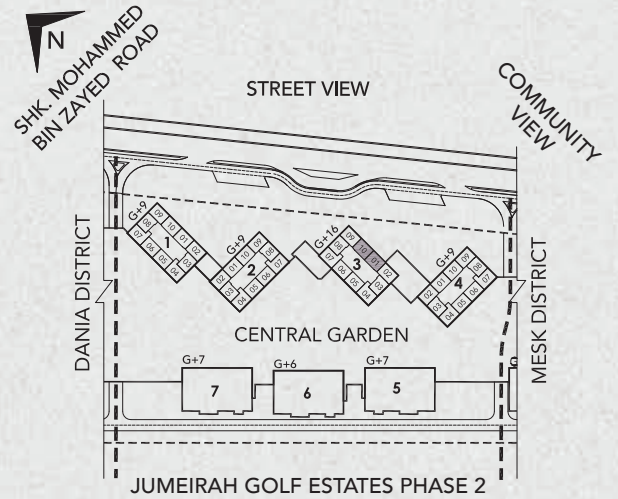
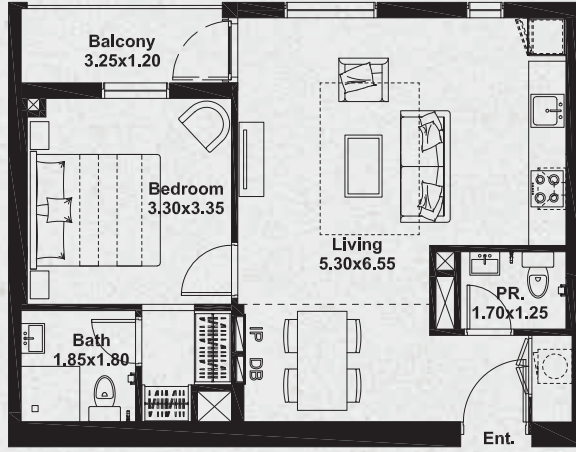

TYPE	LEVEL	UNIT (SQ.FT)	BALCONY (SQ.FT)	TOTAL (SQ.FT)
1BR/B*	1-8	610	51	661

NOOR 3

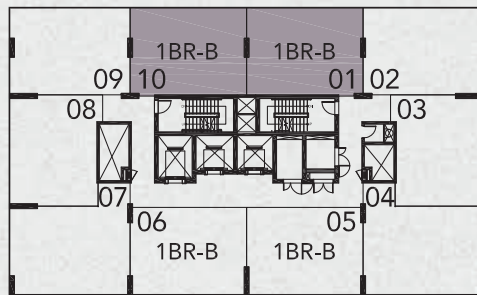

LEVEL 2-8

NOOR 3

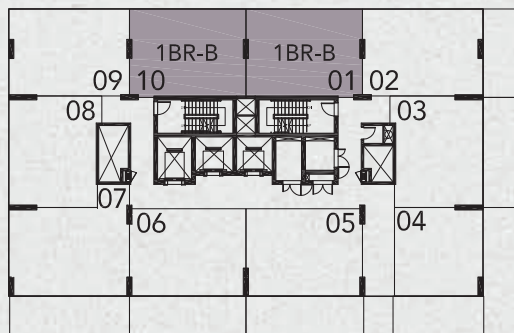

LEVEL 1

نور 1, 2, 3 & 4
شقة مكونة من غرفة نوم واحدة - نموذج C
NOOR 1, 2, 3 & 4
ONE BEDROOM APARTMENT - TYPE C

1BR/C

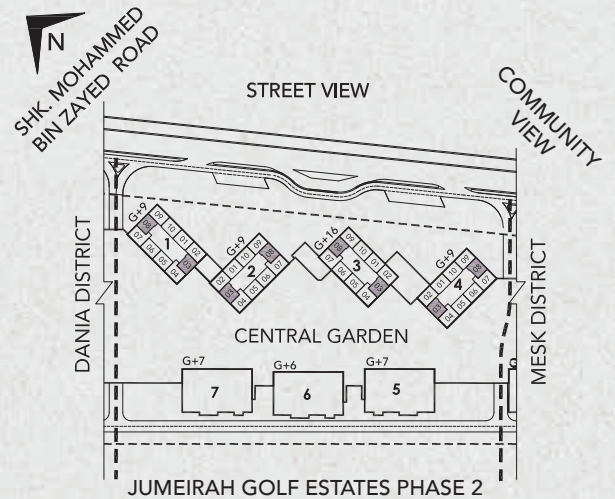
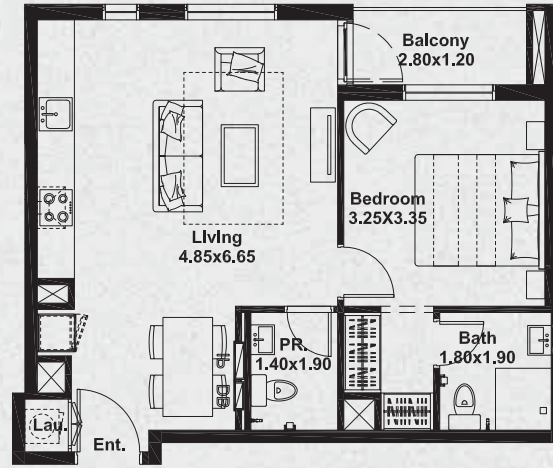

TYPE	LEVEL	UNIT (SQ.FT)	BALCONY (SQ.FT)	TOTAL (SQ.FT)
1BR/C	1-16	578	43	621

NOOR 2 & 4

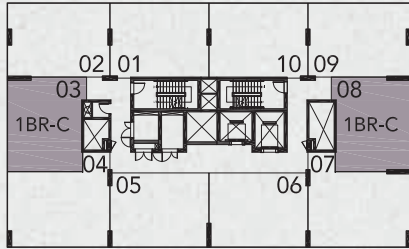

LEVEL 2-9

NOOR 3

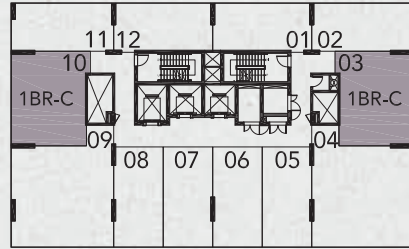

LEVEL 10-16

NOOR 2 & 4

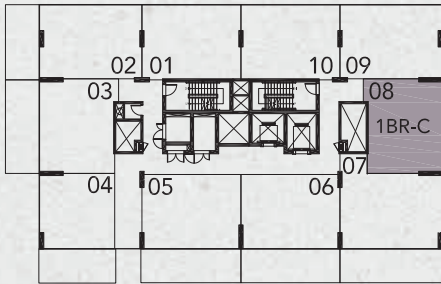

LEVEL 1

NOOR 3

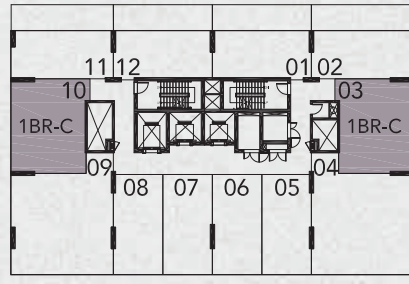

LEVEL 9

NOOR 1

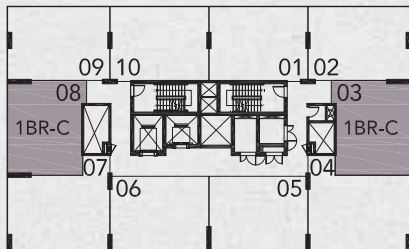

LEVEL 2-9

NOOR 3

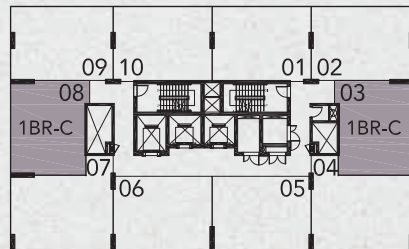

LEVEL 2-8

NOOR 1

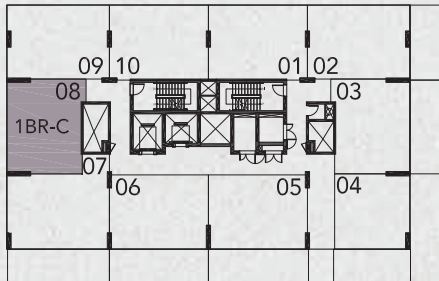

LEVEL 1

NOOR 3

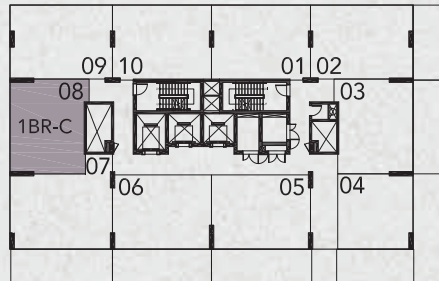

LEVEL 1

نور 1, 2, 3 & 4
شقة مكونة من غرفة نوم واحدة - نموذج C1
NOOR 1, 2, 3 & 4
ONE BEDROOM APARTMENT - TYPE C1

1BR/C1

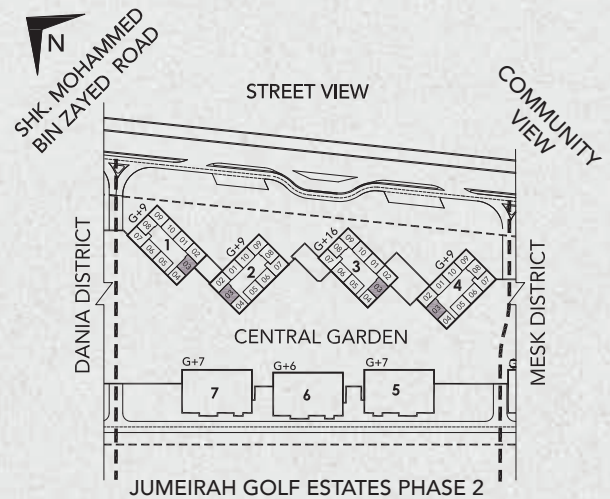
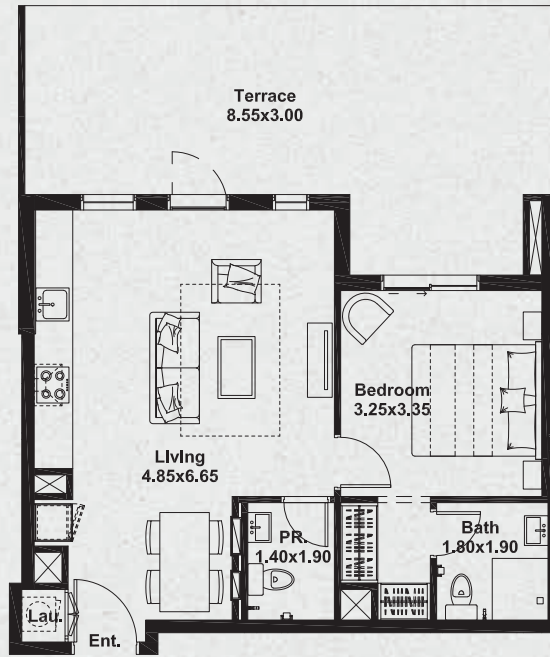

TYPE	LEVEL	UNIT (SQ.FT)	BALCONY (SQ.FT)	TOTAL (SQ.FT)
1BR/C1	1	578	337	915

NOOR 3

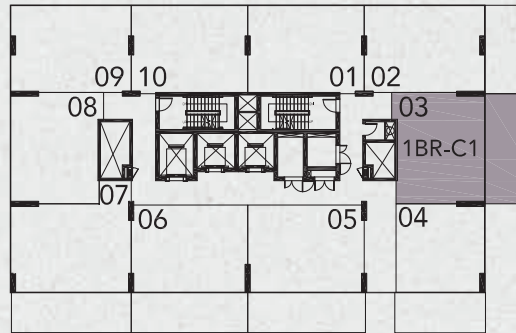

LEVEL 1

NOOR 2 & 4

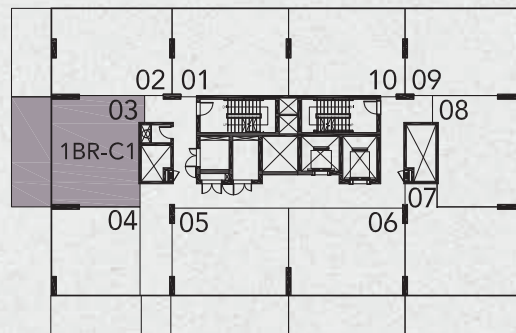

LEVEL 1

NOOR 1

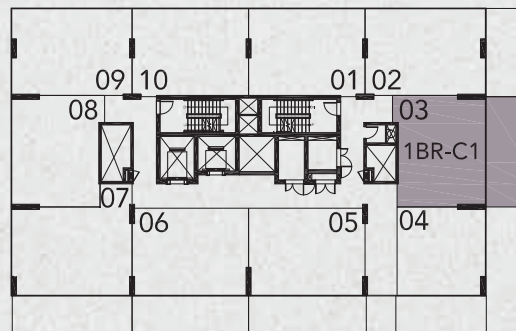

LEVEL 1

نور 1, 2, 3 & 4
شقة مكونة من غرفة نوم واحدة - نموذج D
NOOR 1, 2, 3 & 4
ONE BEDROOM APARTMENT - TYPE D

1BR/D

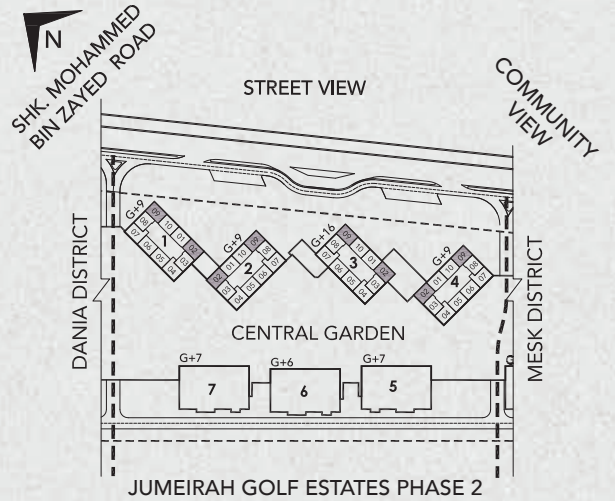
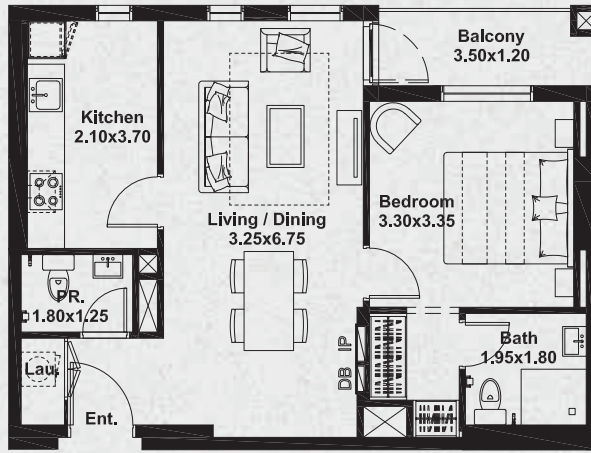

TYPE	LEVEL	UNIT (SQ.FT)	BALCONY (SQ.FT)	TOTAL (SQ.FT)
1BR/D	1-9	628	52	680

NOOR 2 & 4

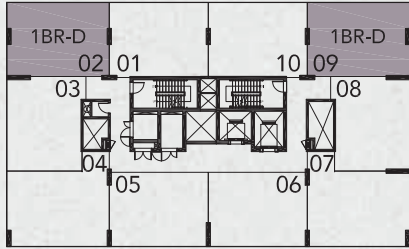

LEVEL 2-9

NOOR 2 & 4

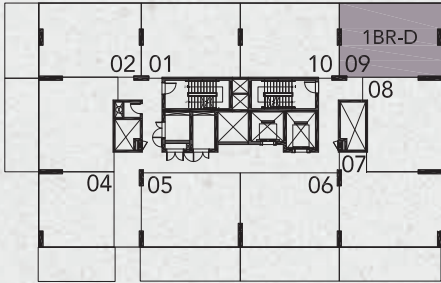

LEVEL 1

NOOR 1

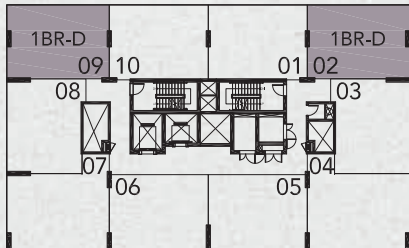

LEVEL 2-9

NOOR 3

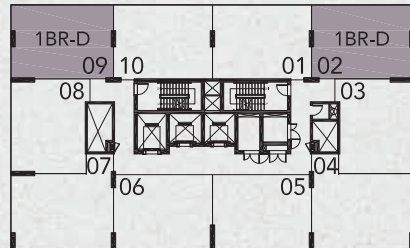

LEVEL 2-8

NOOR 1

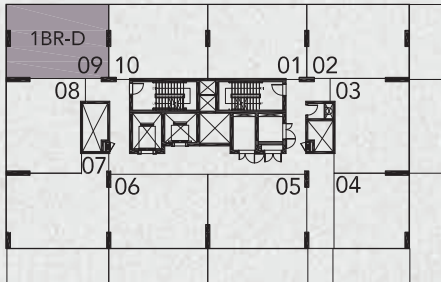

LEVEL 1

NOOR 3

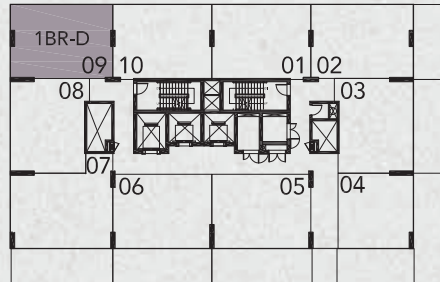

LEVEL 1

نور 1, 2, 3 & 4
شقة مكونة من غرفة نوم واحدة - نموذج D1
NOOR 1, 2, 3 & 4
ONE BEDROOM APARTMENT - TYPE D1

1BR/D1

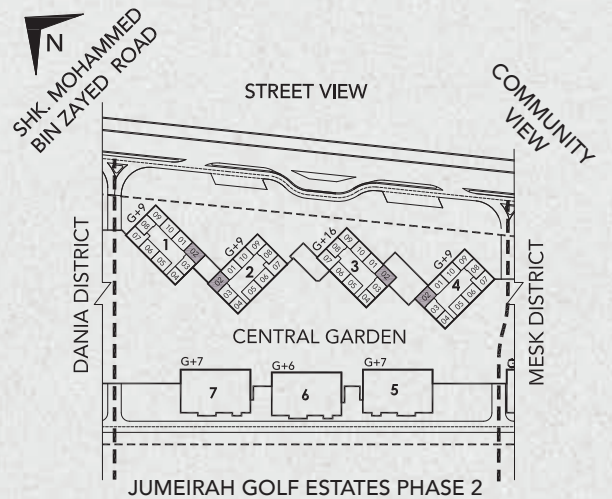
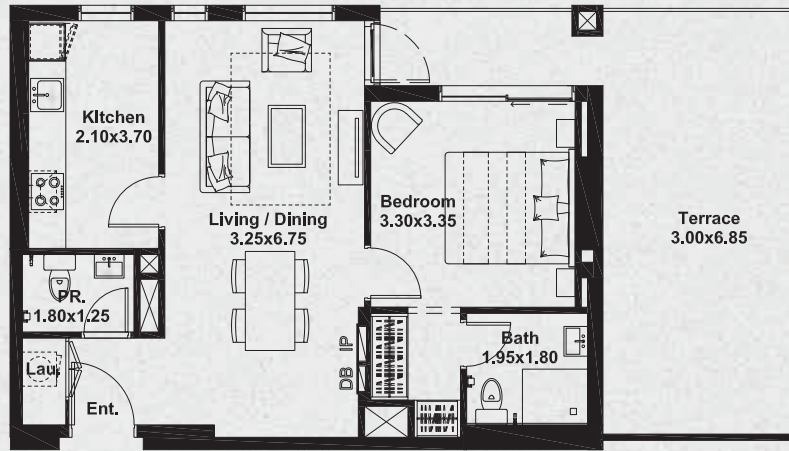

TYPE	LEVEL	UNIT (SQ.FT)	BALCONY (SQ.FT)	TOTAL (SQ.FT)
1BR/D1	1	628	288	916

NOOR 3

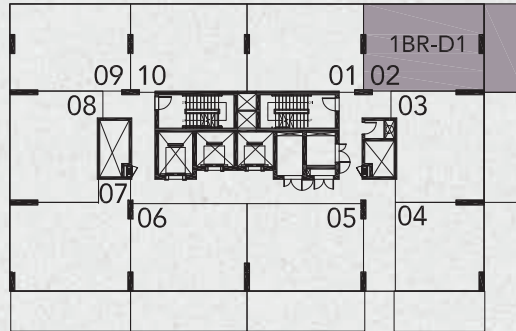

LEVEL 1

NOOR 2 & 4

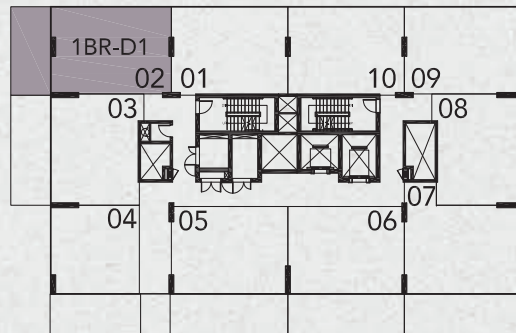

LEVEL 1

NOOR 1

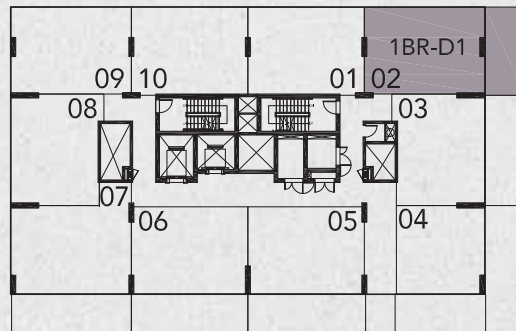

LEVEL 1

نور 1, 2, 3 & 4
شقة مكونة من غرفة نوم واحدة - نموذج E
NOOR 1, 2, 3 & 4
ONE BEDROOM APARTMENT - TYPE E

1BR/E

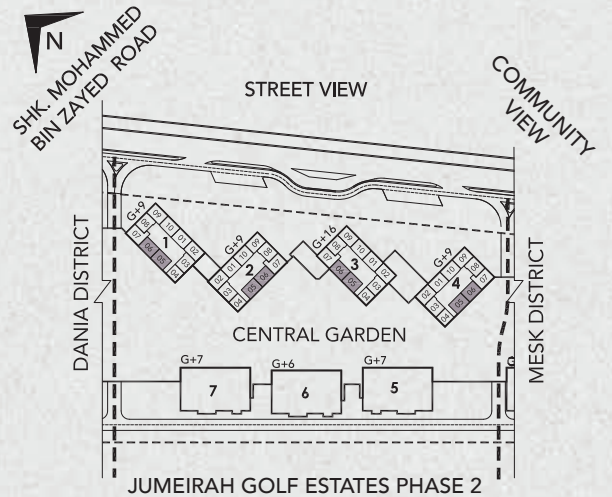
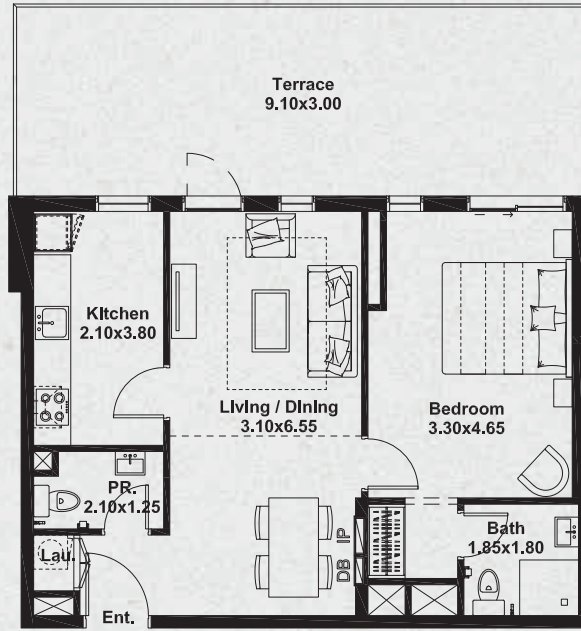

TYPE	LEVEL	UNIT (SQ.FT)	BALCONY (SQ.FT)	TOTAL (SQ.FT)
1BR/E	1	636	313	949
	1	636	317	953

NOOR 3

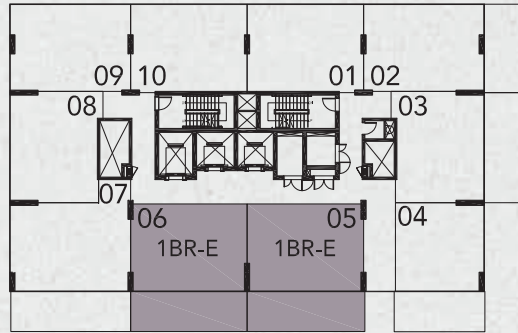

LEVEL 1

NOOR 2 & 4

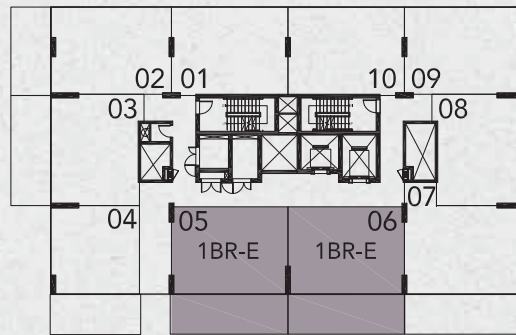

LEVEL 1

NOOR 1

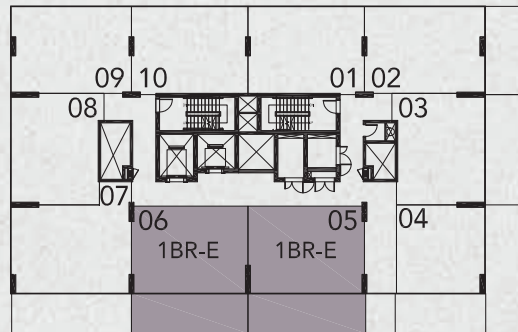

LEVEL 1

شقة مكونة من غرفة نوم واحدة - نموذج F
NOOR 1, 2, 3 & 4
ONE BEDROOM APARTMENT - TYPE F

1BR/F

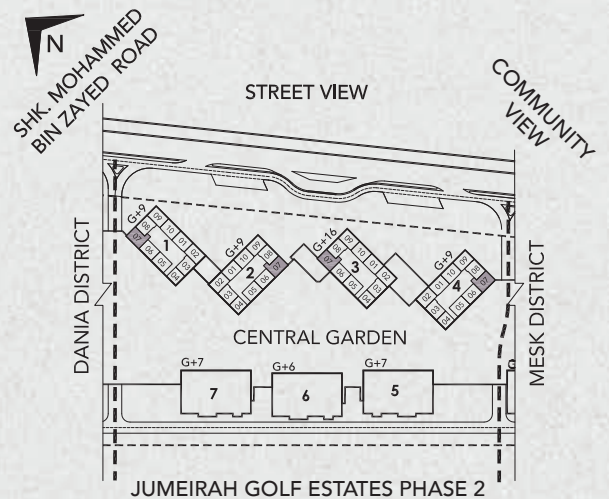
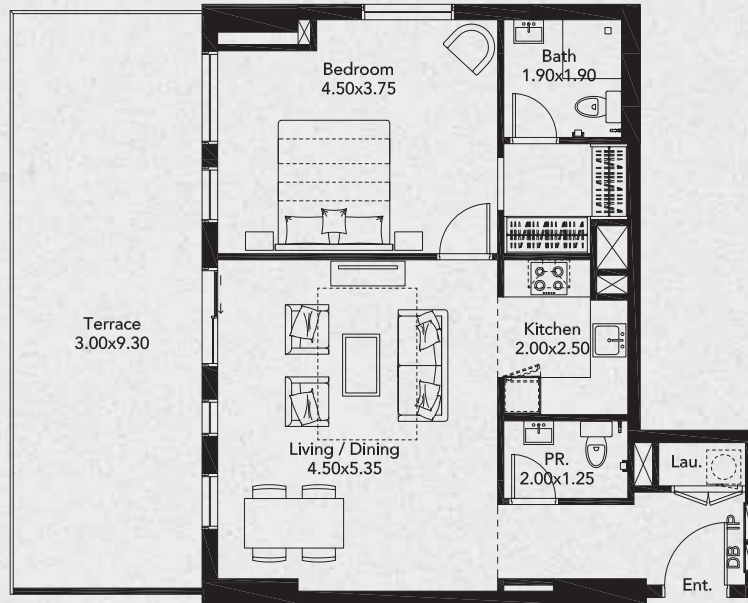

TYPE	LEVEL	UNIT (SQ.FT)	BALCONY (SQ.FT)	TOTAL (SQ.FT)
1BR/F	1	726	322	1,048

NOOR 3

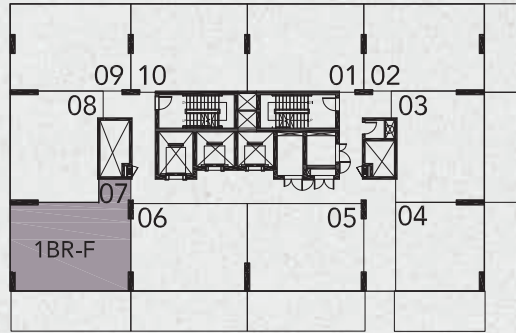

LEVEL 1

NOOR 2 & 4

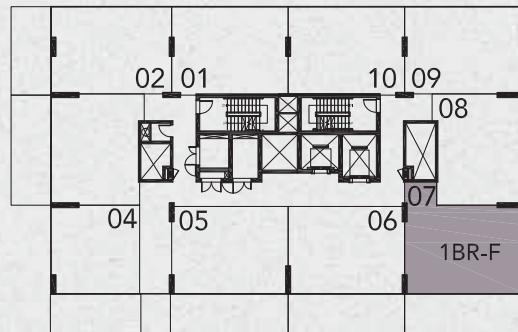

LEVEL 1

NOOR 1

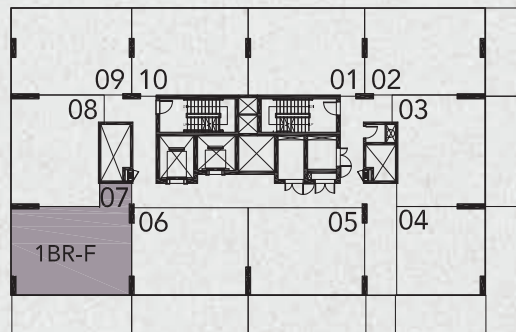

LEVEL 1

نور 5, 6 & 7
شقة مكونة من غرفة نوم واحدة - نموذج G
NOOR 5, 6 & 7
ONE BEDROOM APARTMENT - TYPE G

1BR/G

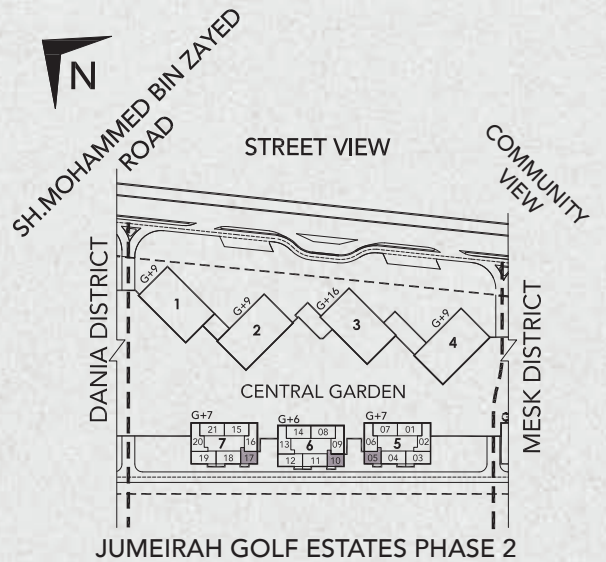
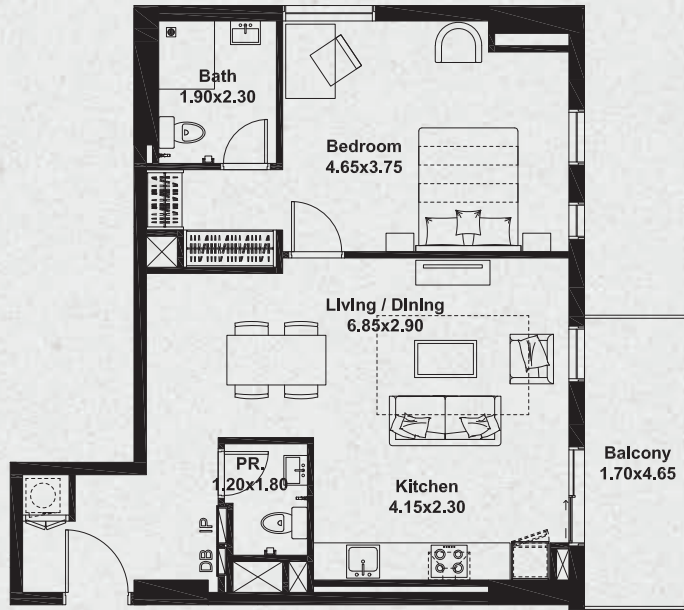

TYPE	LEVEL	UNIT (SQ.FT)	BALCONY (SQ.FT)	TOTAL (SQ.FT)
1BR/G	2-4	737	95	832

LEVEL 2-4

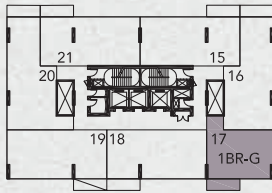

NOOR 7

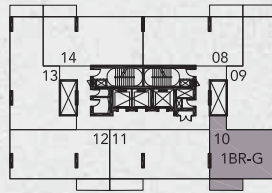

NOOR 6

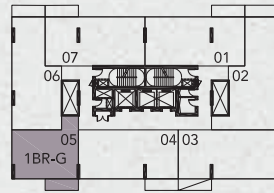

NOOR 5

نور 5, 6 & 7
شقة مكونة من غرفة نوم واحدة - نموذج H
NOOR 5, 6 & 7
ONE BEDROOM APARTMENT - TYPE H

1BR/H

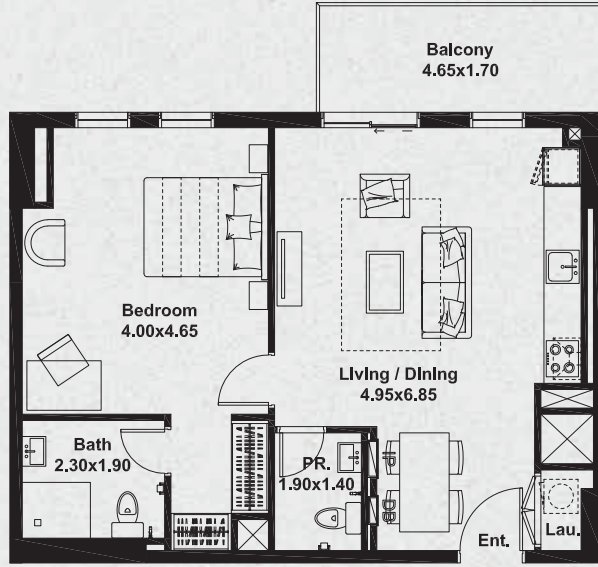

TYPE	LEVEL	UNIT (SQ.FT)	BALCONY (SQ.FT)	TOTAL (SQ.FT)
1BR/H	M	694	95	789
	1			
	5-6			
	7			

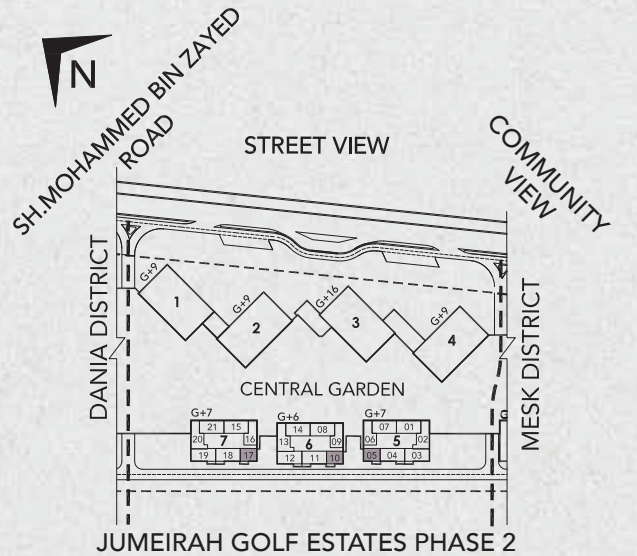

LEVEL 7

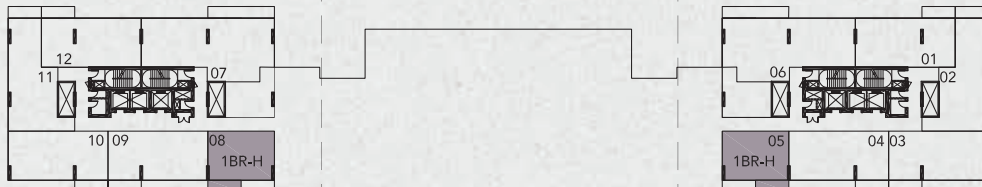

LEVEL 5-6

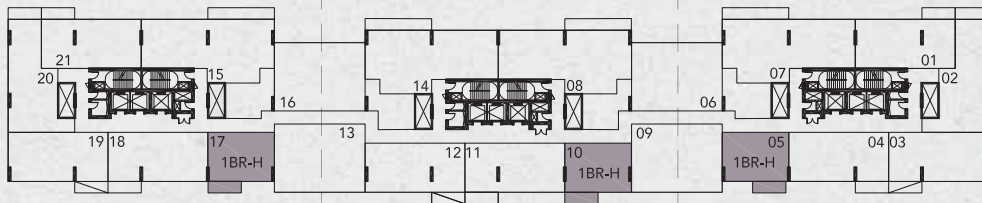

LEVEL 1

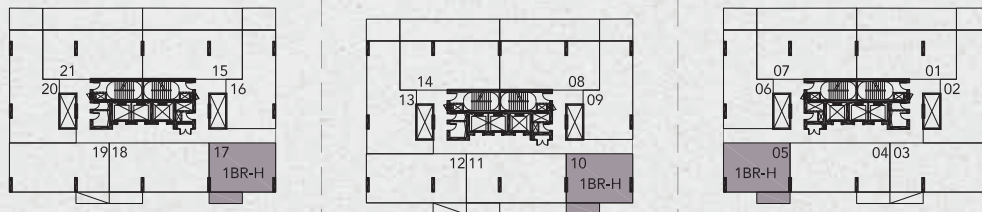

LEVEL M

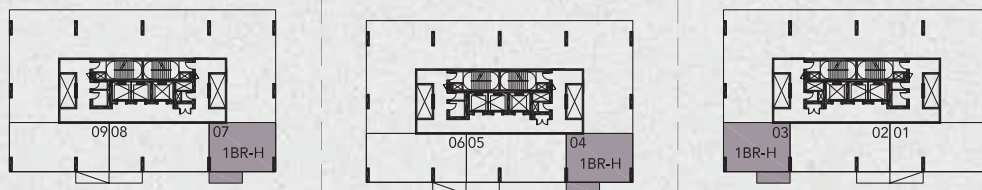

NOOR 7

NOOR 6

NOOR 5

شقة مكونة من غرفة نوم واحدة - نموذج 1
NOOR 5, 6 & 7
ONE BEDROOM APARTMENT - TYPE I

1BR/I

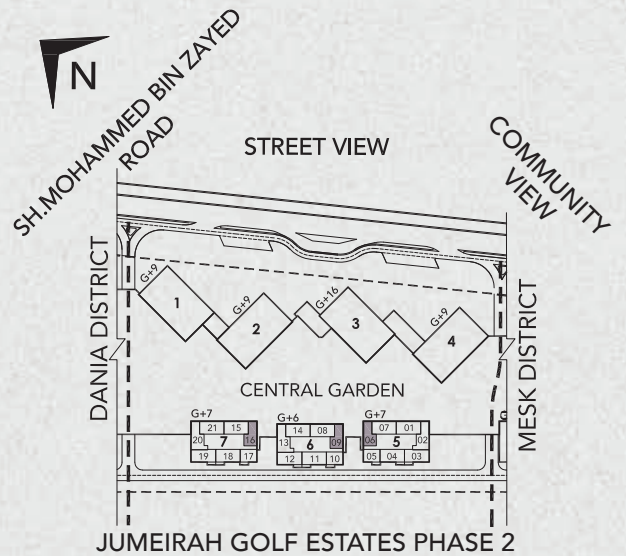
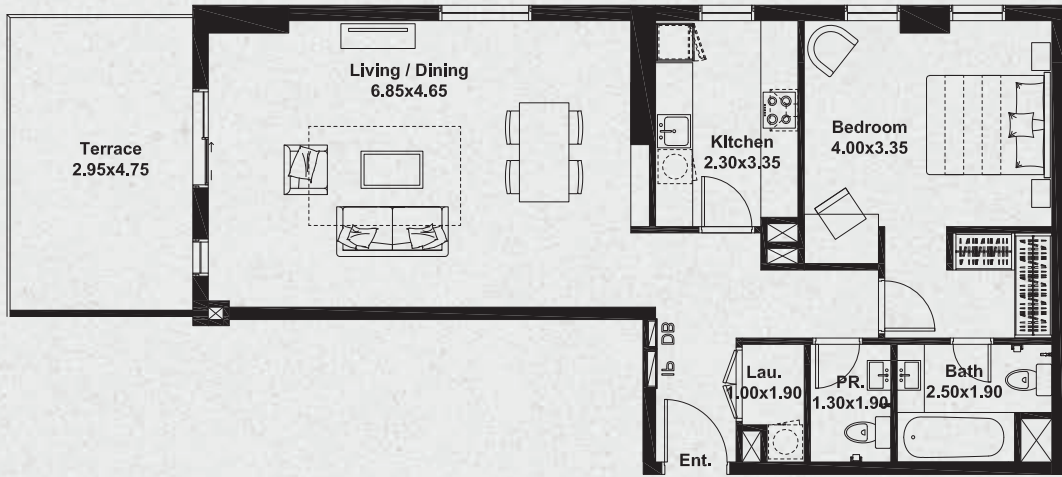

TYPE	LEVEL	UNIT (SQ.FT)	BALCONY (SQ.FT)	TOTAL (SQ.FT)
1BR/I	1	886	160	1,047

LEVEL 1

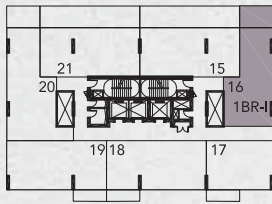

NOOR 7

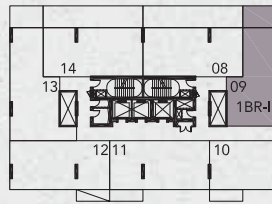

NOOR 6

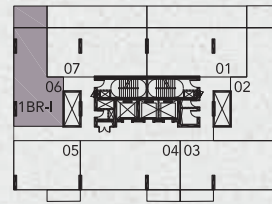

NOOR 5

نور 3
شقة مكونة من غرفتي نوم - نموذج A
NOOR 3
TWO BEDROOM APARTMENT - TYPE A

2BR/A

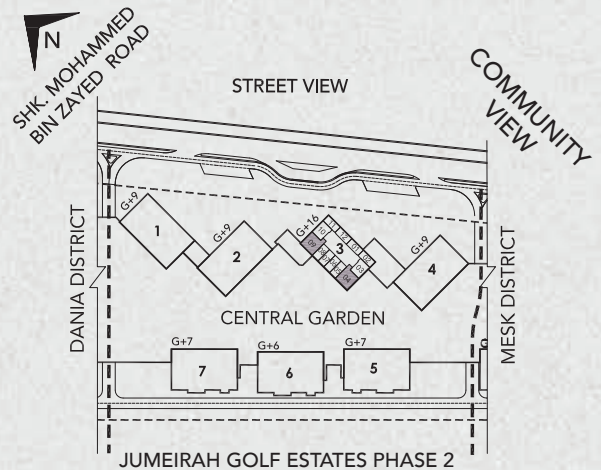
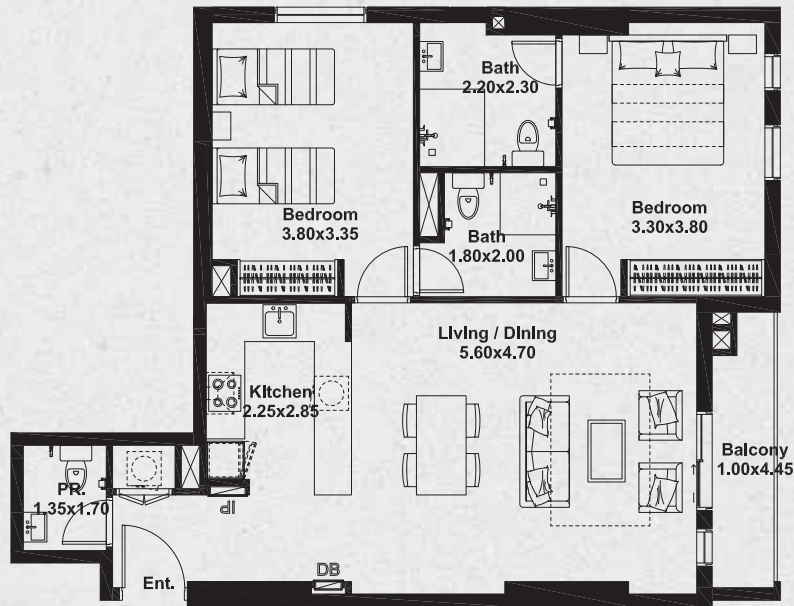

TYPE	LEVEL	UNIT (SQ.FT)	BALCONY (SQ.FT)	TOTAL (SQ.FT)
2BR/A	09-16	939	54	993

NOOR 3

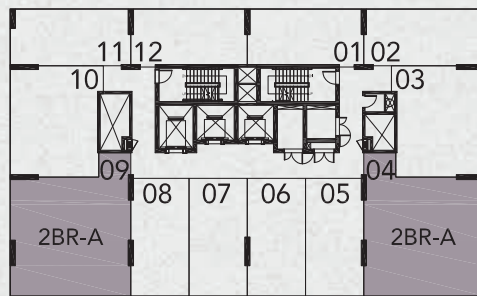

LEVEL 10-16

NOOR 3

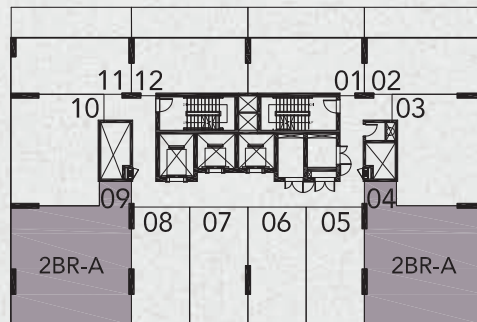

LEVEL 9

نور 5, 6 , 7 & 6
شقة مكونة من غرفتي نوم - نموذج B
NOOR 5, 6 & 7
TWO BEDROOM APARTMENT - TYPE B

2BR/B

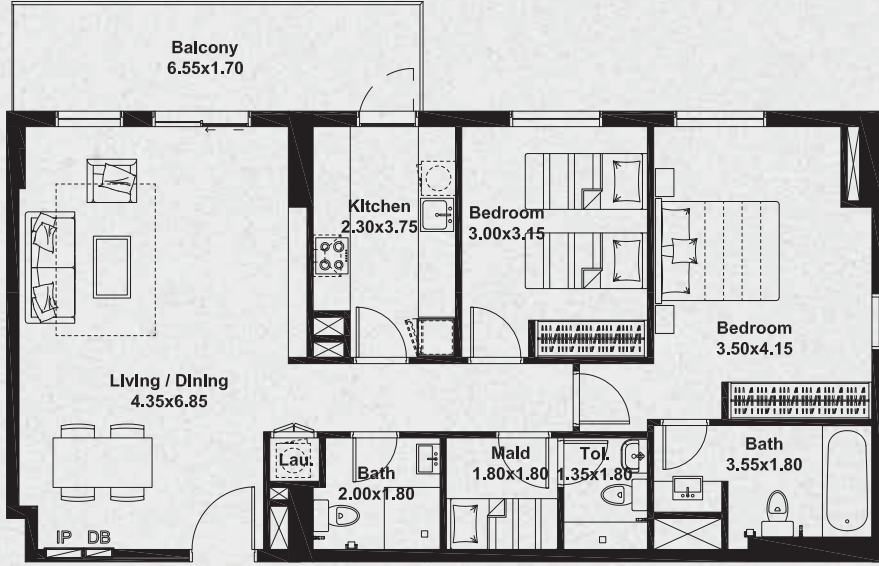

TYPE	LEVEL	UNIT (SQ.FT)	BALCONY (SQ.FT)	TOTAL (SQ.FT)
2BR/B	M	1,033	133	1,166
	1-4			
	5-6			
	7			

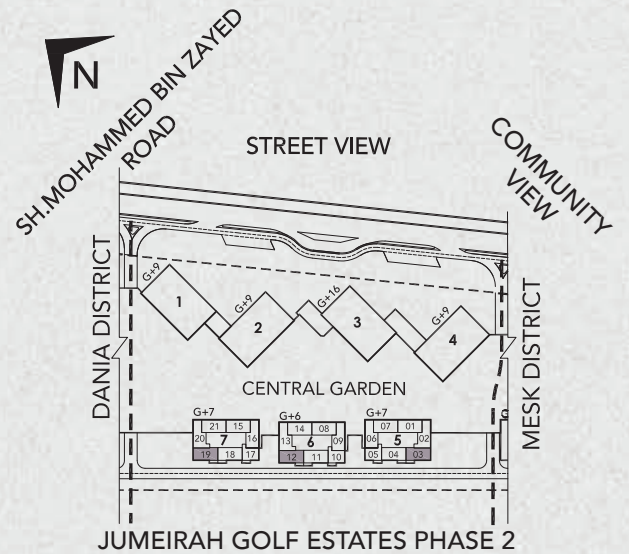

LEVEL 7

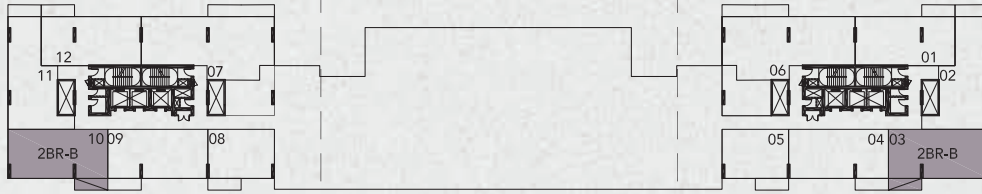

LEVEL 5-6

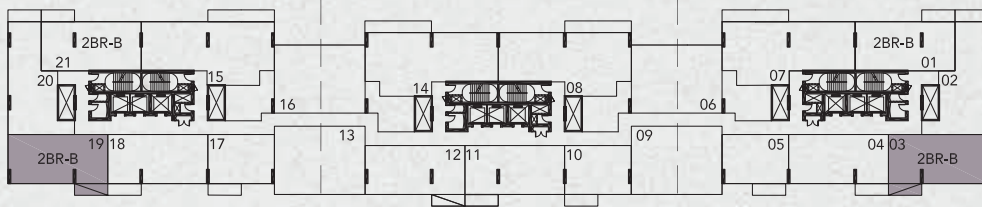

LEVEL 2-4

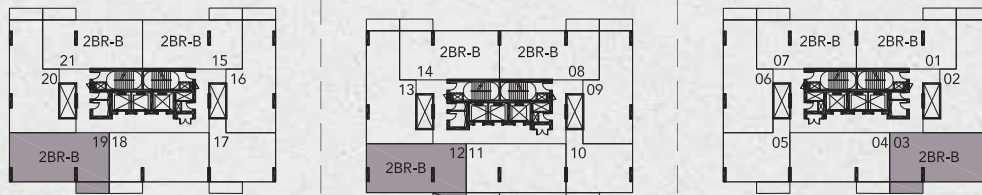

LEVEL 1

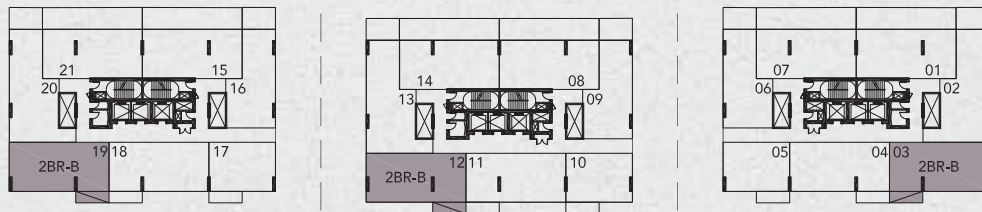

LEVEL M

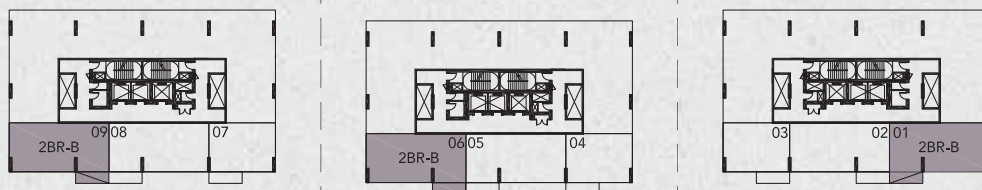

NOOR 7

NOOR 6

NOOR 5

نور 5, 6 & 7
شقة مكونة من غرفتي نوم - نموذج *B
NOOR 5, 6 & 7
TWO BEDROOM APARTMENT - TYPE B*

2BR/B*

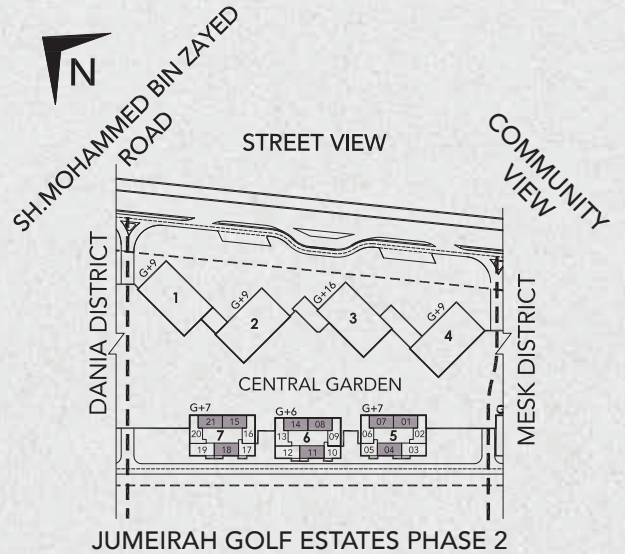
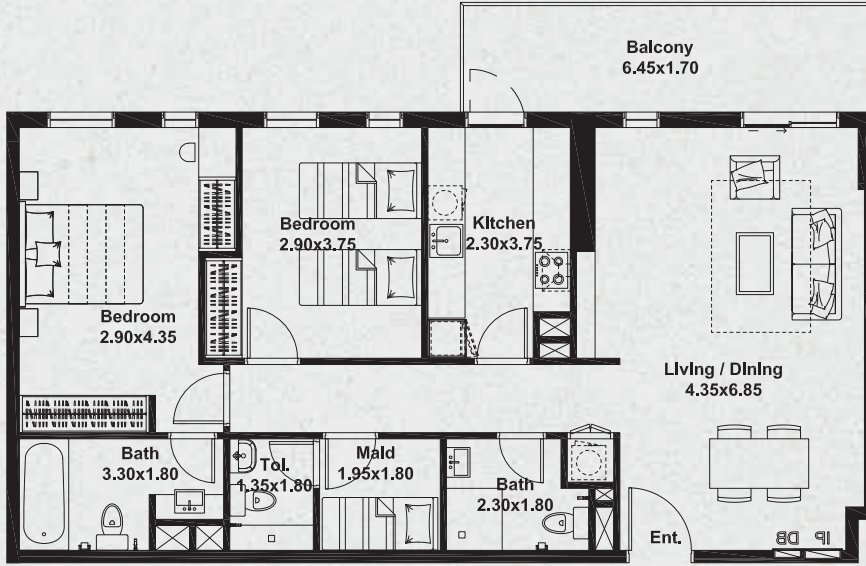

TYPE	LEVEL	UNIT (SQ.FT)	BALCONY (SQ.FT)	TOTAL (SQ.FT)
2BR/B*	M	1,032	133	1,165
	1-4			
	5-6			
	7	1,054	130	1,184
	2-4			
	5-6			
7				

LEVEL 7

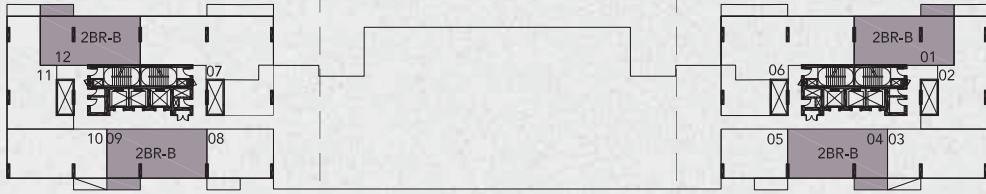

LEVEL 5-6

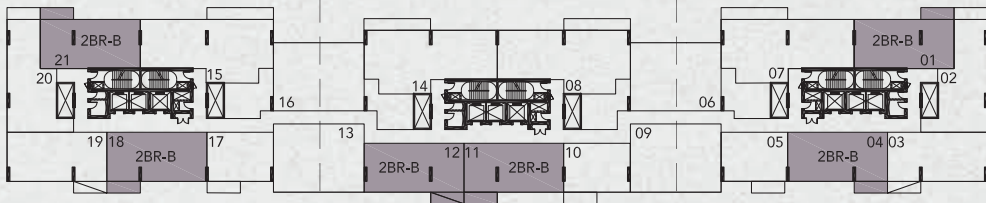

LEVEL 2-4

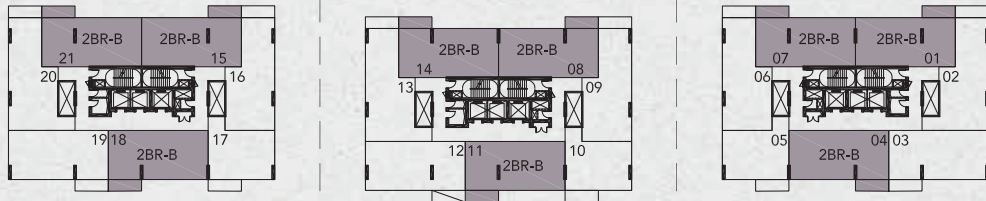

LEVEL 1

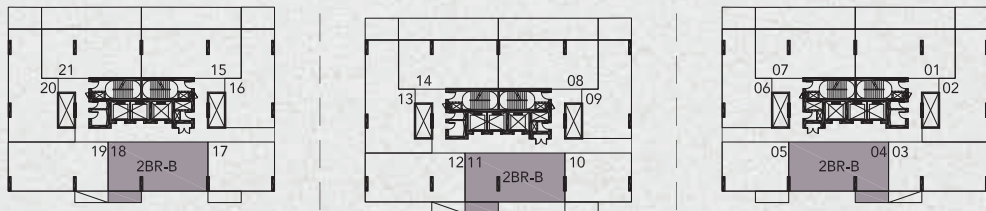

LEVEL M

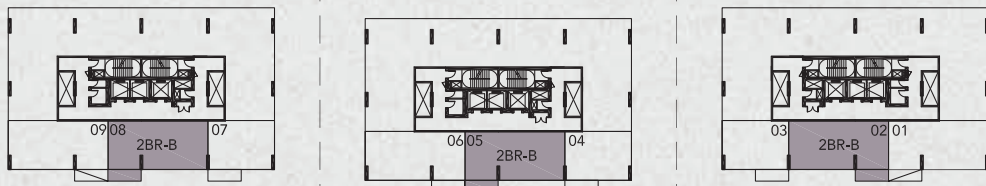

NOOR 7

NOOR 6

NOOR 5

نور 5, 6 & 7
شقة مكونة من غرفتي نوم - نموذج C
NOOR 5, 6 & 7
TWO BEDROOM APARTMENT - TYPE C

2BR/C

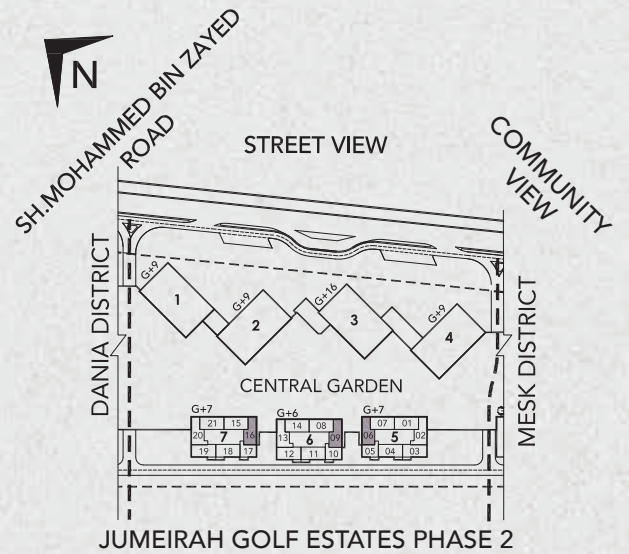
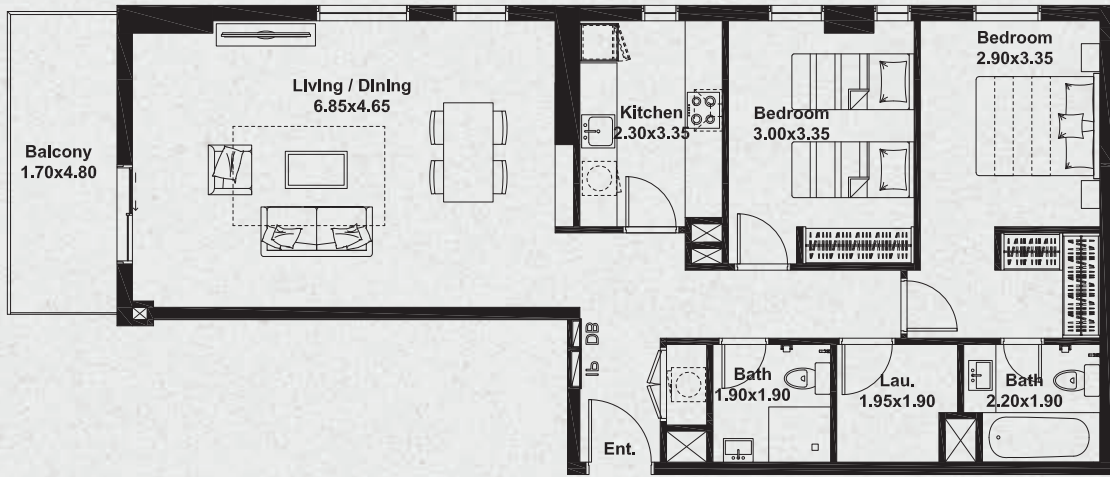

TYPE	LEVEL	UNIT (SQ.FT)	BALCONY (SQ.FT)	TOTAL (SQ.FT)
2BR/C	2-4	1,043	98	1,141

LEVEL 2-4

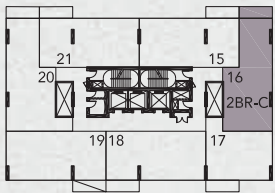

NOOR 7

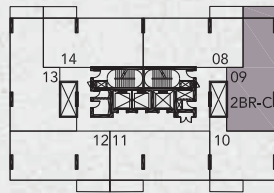

NOOR 6

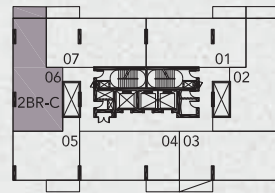

NOOR 5

نور 5, 6 & 7
شقة مكونة من غرفتي نوم - نموذج D
NOOR 5, 6 & 7
TWO BEDROOM APARTMENT - TYPE D

2BR/D

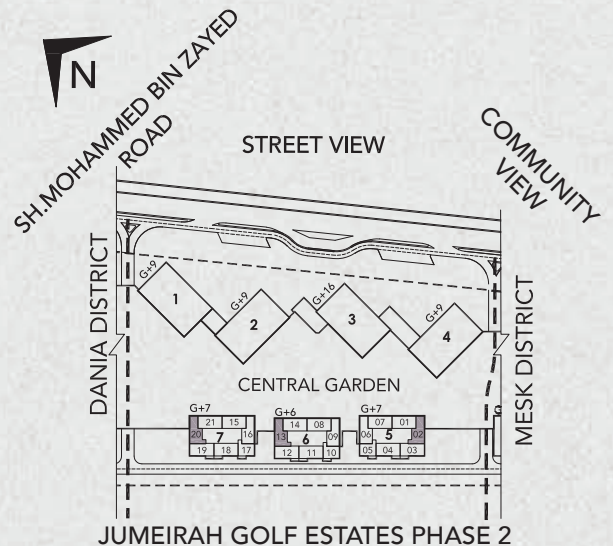
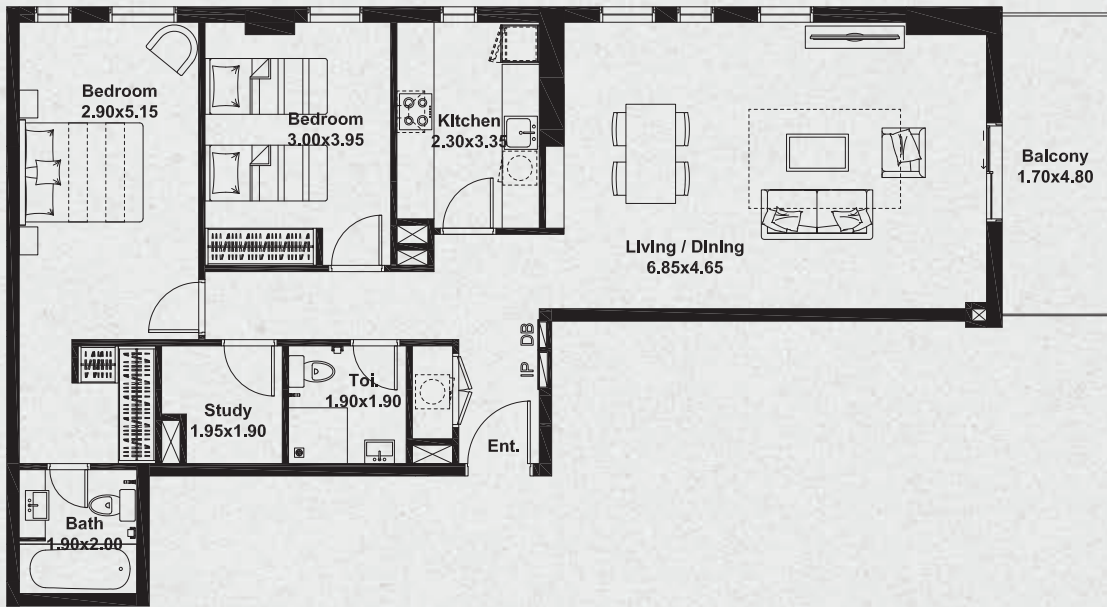

TYPE	LEVEL	UNIT (SQ.FT)	BALCONY (SQ.FT)	TOTAL (SQ.FT)
2BR/D	2-4	1,094	98	1,192
	5-6			
	7			

LEVEL 7



LEVEL 5-6

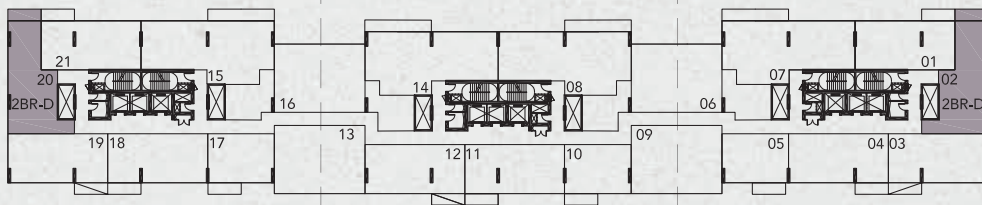

LEVEL 2-4

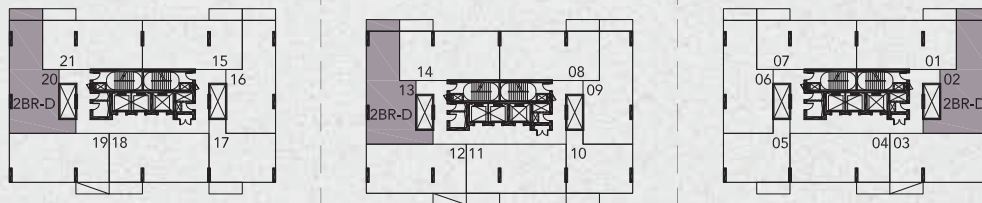

NOOR 7

NOOR 6

NOOR 5

نور 5, 6 & 7
شقة مكونة من غرفتي نوم - نموذج E
NOOR 5, 6 & 7
TWO BEDROOM APARTMENT - TYPE E

2BR/E

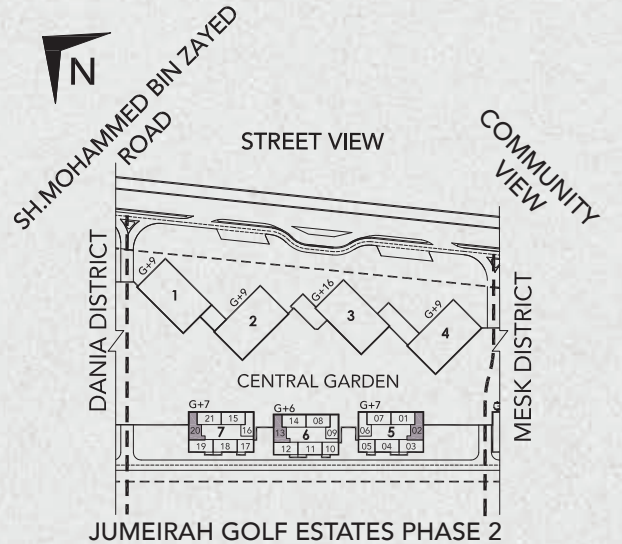
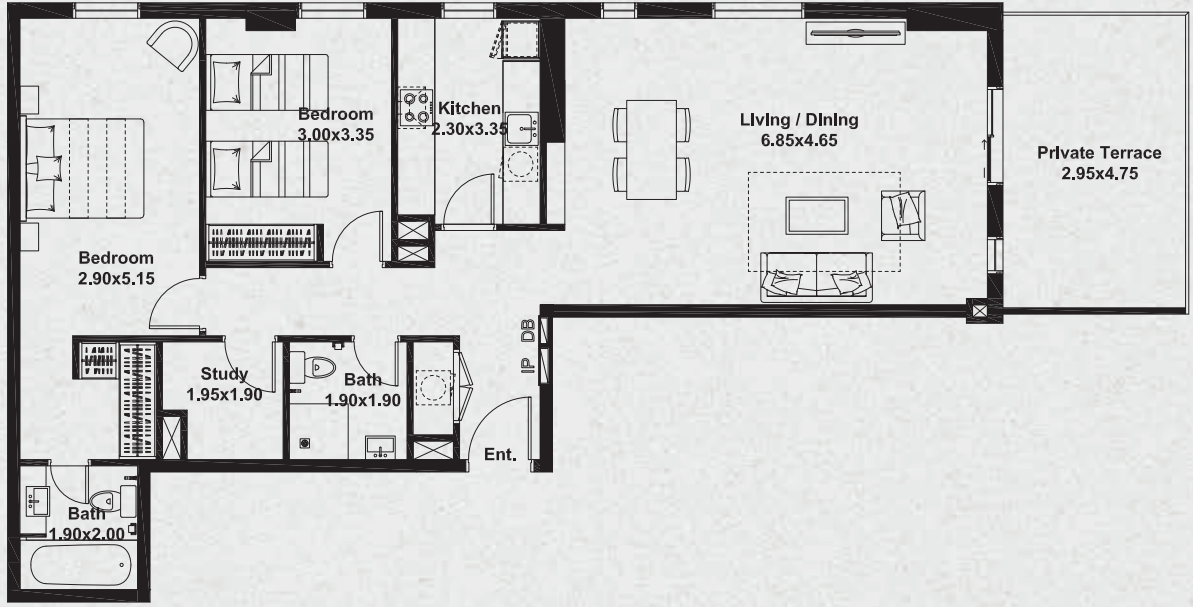

TYPE	LEVEL	UNIT (SQ.FT)	BALCONY (SQ.FT)	TOTAL (SQ.FT)
2BR/E	1	1,094	160	1,254

LEVEL 1

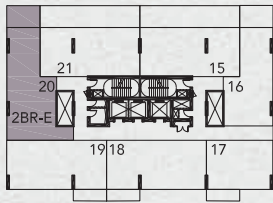

NOOR 7

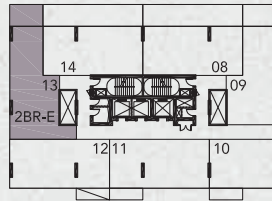

NOOR 6

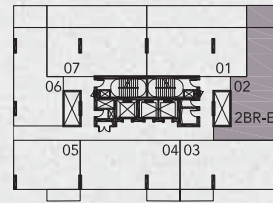

NOOR 5

نور 5, 6 & 7
شقة مكونة من غرفتي نوم - نموذج F
NOOR 5, 6 & 7
TWO BEDROOM APARTMENT - TYPE F

2BR/F

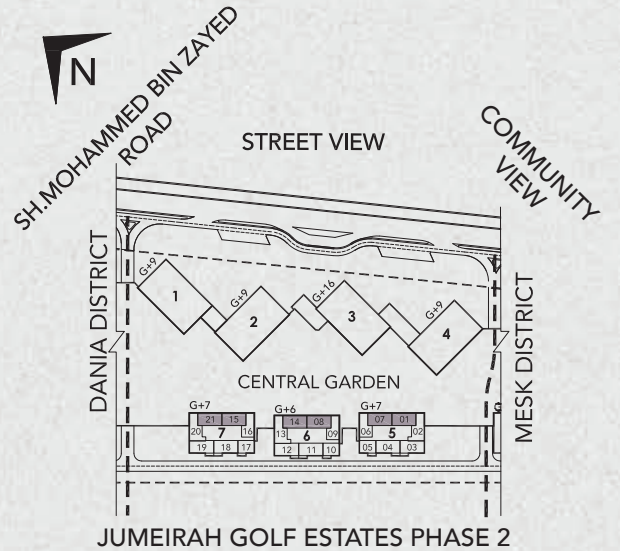
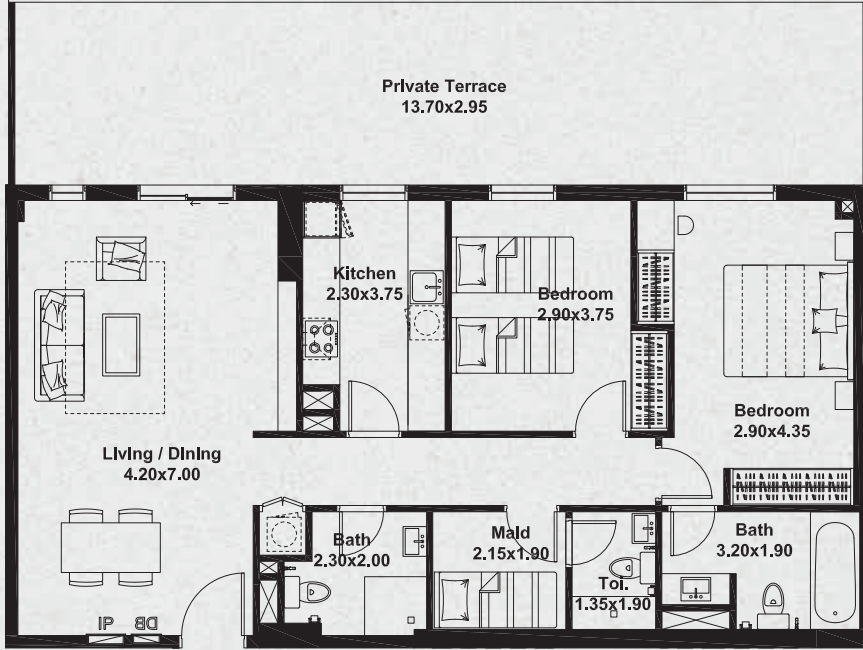

TYPE	LEVEL	UNIT (SQ.FT)	BALCONY (SQ.FT)	TOTAL (SQ.FT)
2BR/F	1	1,055	460	1,515

LEVEL 1

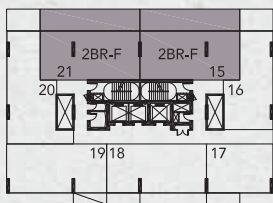

NOOR 7

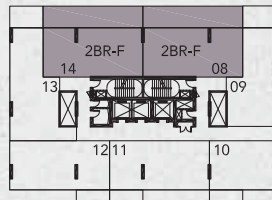

NOOR 6

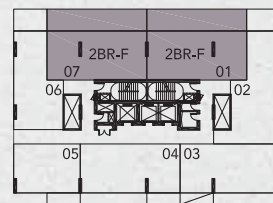

NOOR 5

نور 5, 6 & 7
شقة مكونة من غرفتي نوم - نموذج G
NOOR 5, 6 & 7
TWO BEDROOM APARTMENT - TYPE G

2BR/G

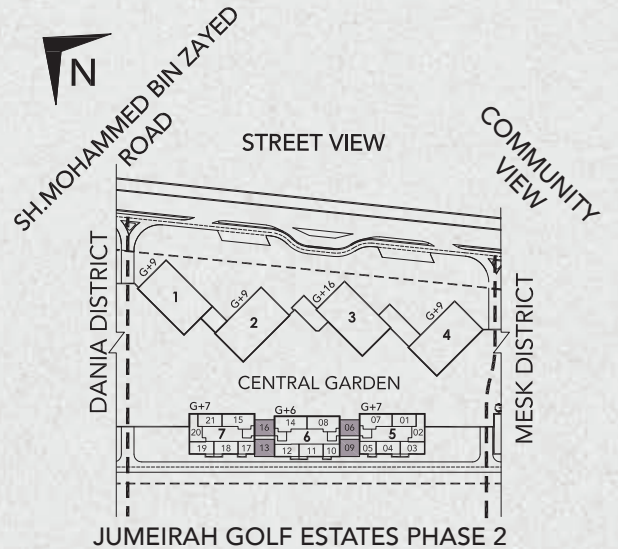
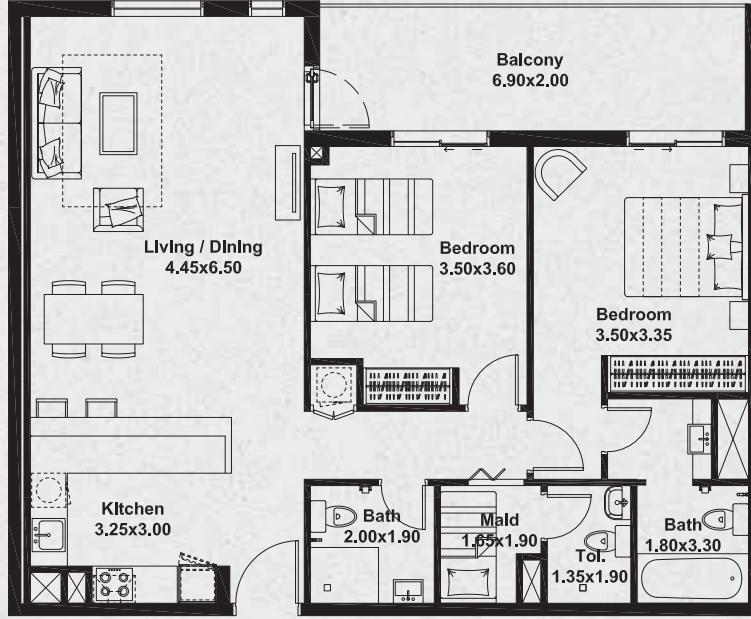

TYPE	LEVEL	UNIT (SQ.FT)	BALCONY (SQ.FT)	TOTAL (SQ.FT)
2BR/G	5-6	1,063	165	1,228
	5-6	1,105	133	1,238

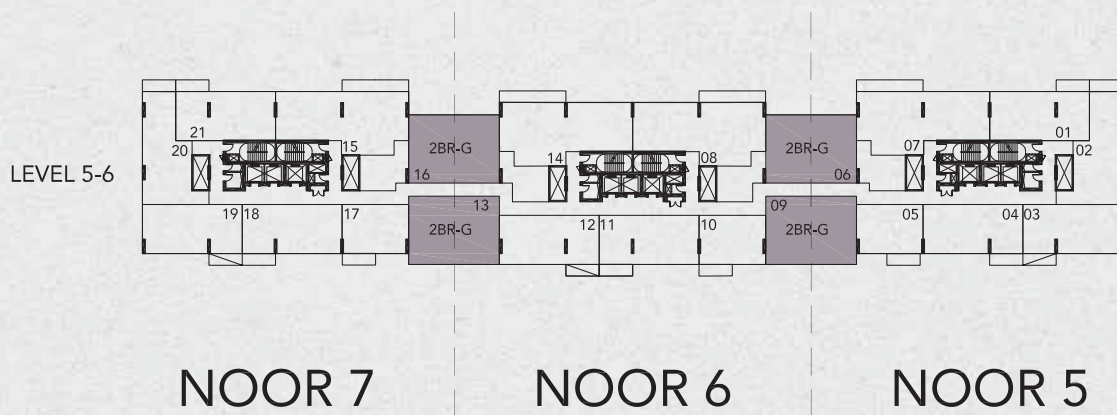

نور 5, 6 & 7
شقة مكونة من ثلاث غرف نوم - نموذج A
NOOR 5, 6 & 7
THREE BEDROOM APARTMENT - TYPE A

3BR/A

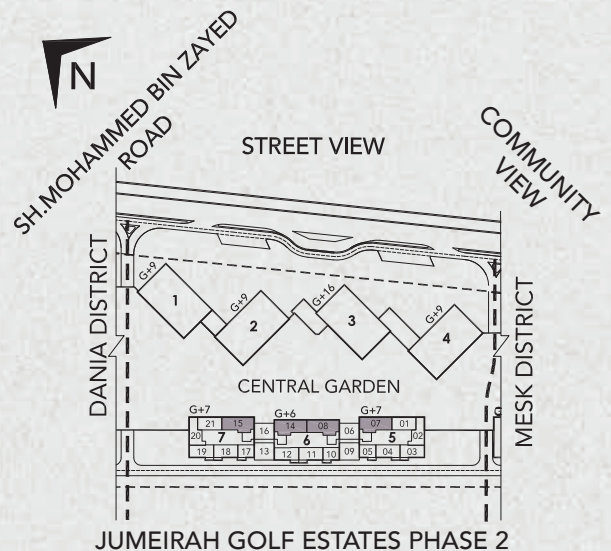
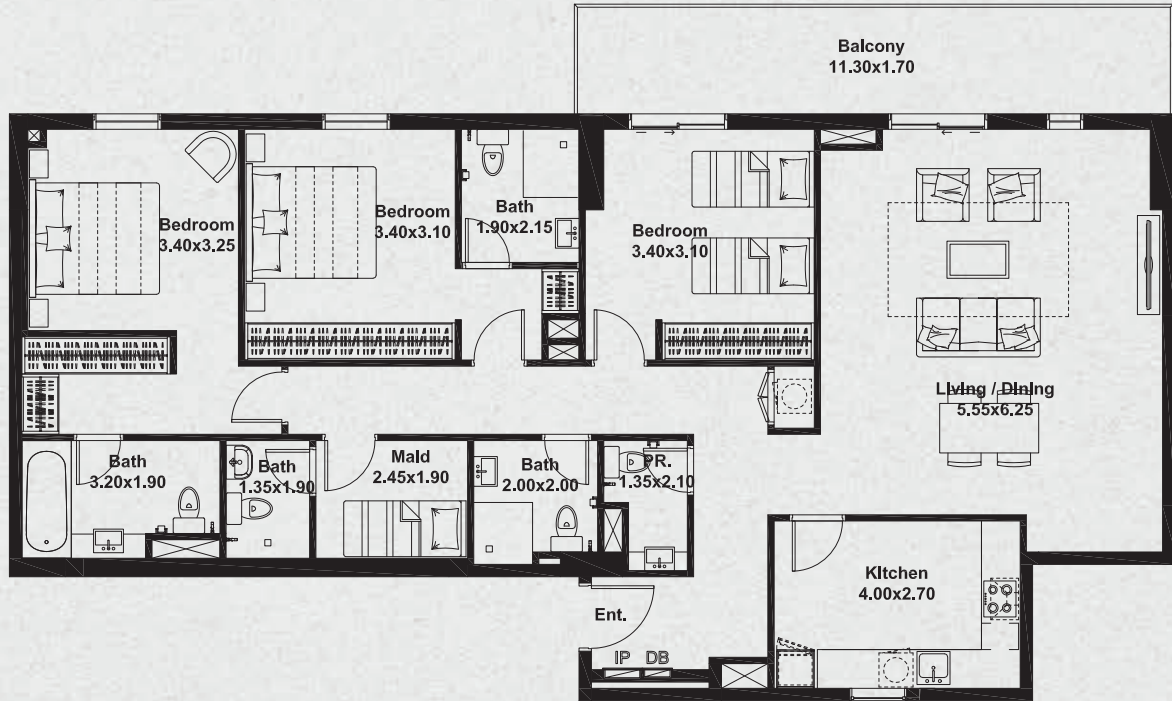

TYPE	LEVEL	UNIT (SQ.FT)	BALCONY (SQ.FT)	TOTAL (SQ.FT)
3BR/A	5-7	1,572	232	1,804

